

SERVICE MANUAL

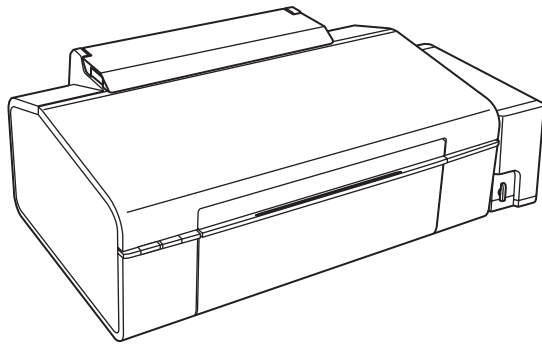

Color Inkjet Printer

L800/L801

EPSON
EXCEED YOUR VISION

Confidential
SEMF10-008

Notice:

- All rights reserved. No part of this manual may be reproduced, stored in a retrieval system, or transmitted in any form or by any means, electronic, mechanical, photocopying, recording, or otherwise, without the prior written permission of SEIKO EPSON CORPORATION.
- All effort have been made to ensure the accuracy of the contents of this manual. However, should any errors be detected, SEIKO EPSON would greatly appreciate being informed of them.
- The contents of this manual are subject to change without notice.
- The above notwithstanding SEIKO EPSON CORPORATION can assume no responsibility for any errors in this manual or the consequences thereof.

EPSON is a registered trademark of SEIKO EPSON CORPORATION.

Note :Other product names used herein are for identification purpose only and may be trademarks or registered trademarks of their respective owners. EPSON disclaims any and all rights in those marks.

Copyright © 2011 **SEIKO EPSON CORPORATION**
I&I CS Quality Assurance Department

Safety Precautions

All safety procedures described here shall be strictly adhered to by all parties servicing and maintaining this product.

DANGER

Strictly observe the following cautions. Failure to comply could result in serious bodily injury or loss of life.

1. Always disconnect the product from the power source and peripheral devices when servicing the product or performing maintenance.
2. When performing works described in this manual, do not connect to a power source until instructed to do so. Connecting to a power source causes high voltage in the power supply unit and some electronic components even if the product power switch is off. If you need to perform the work with the power cable connected to a power source, use extreme caution to avoid electrical shock.

WARNING

Strictly observe the following cautions. Failure to comply may lead to personal injury or loss of life.

1. Always wear protective goggles for disassembly and reassembly to protect your eyes from ink in working. If any ink gets in your eyes, wash your eyes with clean water and consult a doctor immediately.
2. When using compressed air products; such as air duster, for cleaning during repair and maintenance, the use of such products containing flammable gas is prohibited.

PRECAUTIONS

Strictly observe the following cautions. Failure to comply may lead to personal injury or damage of the product.

1. Repairs on Epson product should be performed only by an Epson certified repair technician.
2. No work should be performed on this product by persons unfamiliar with basic safety knowledge required for electrician.
3. The power rating of this product is indicated on the serial number/rating plate. Never connect this product to the power source whose voltages is different from the rated voltage.
4. Replace malfunctioning components only with those components provided or approved by Epson; introduction of second-source ICs or other non-approved components may damage the product and void any applicable Epson warranty.
5. In order to protect sensitive microprocessors and circuitry, use static discharge equipment, such as anti-static wrist straps, when accessing internal components.
6. Do not tilt this product immediately after initial ink charge, especially after performing the ink charge several times. Doing so may cause ink to leak from the product because it may take some time for the waste ink pads to completely absorb ink wasted due to the ink charge.
7. Never touch the ink or wasted ink with bare hands. If ink comes into contact with your skin, wash it off with soap and water immediately. If you have a skin irritation, consult a doctor immediately.
8. When disassembling or assembling this product, make sure to wear gloves to avoid injuries from metal parts with sharp edges.
9. Use only recommended tools for disassembling, assembling or adjusting the printer.
10. Observe the specified torque when tightening screws.
11. Be extremely careful not to scratch or contaminate the following parts.
 - Nozzle plate of the printhead
 - CR Scale
 - PF Scale
 - Coated surface of the PF Roller
 - Gears
 - Rollers
 - Exterior parts
12. Never use oil or grease other than those specified in this manual. Use of different types of oil or grease may damage the component or give bad influence on the printer function.
13. Apply the specified amount of grease described in this manual.
14. Make the specified adjustments when you disassemble the printer.
15. When cleaning this product, follow the procedure described in this manual.
16. When transporting this product after filling the ink in the printhead, pack the printer without removing the ink cartridges in order to prevent the printhead from drying out.
17. Make sure to install antivirus software in the computers used for the service support activities.
18. Keep the virus pattern file of antivirus software up-to-date.

About This Manual

This manual, consists of the following chapters, is intended for repair service personnel and includes information necessary for properly performing maintenance and servicing the product.

Manual Configuration

CHAPTER 1. DISASSEMBLY / REASSEMBLY

Describes the disassembly/reassembly procedures for main parts/units of the product, and provides the standard operation time for servicing the product.

CHAPTER 2. ADJUSTMENT

Describes the required adjustments for servicing the product.

CHAPTER 3. MAINTENANCE

Describes maintenance items and procedures for servicing the product.

CHAPTER 4. APPENDIX

Provides the following additional information for reference:

- Power-On Sequence
- Standard Operation Time for servicing the product
- Troubleshooting

Symbols Used in this Manual

Various symbols are used throughout this manual either to provide additional information on a specific topic or to warn of possible danger present during a procedure or an action. Pay attention to all symbols when they are used, and always read explanation thoroughly and follow the instructions.



Indicates an operating or maintenance procedure, practice or condition that, if not strictly observed, could result in serious injury or loss of life.



Indicates an operating or maintenance procedure, practice, or condition that, if not strictly observed, could result in bodily injury, damage or malfunction of equipment.



May indicate an operating or maintenance procedure, practice or condition that is necessary to accomplish a task efficiently. It may also provide additional information that is related to a specific subject, or comment on the results achieved through a previous action.

For Chapter 1 “Disassembly/Reassembly”, symbols other than indicated above are used to show additional information for disassembly/reassembly. For the details on those symbols, see “[1.2 Disassembly/Reassembly Procedures \(p17\)](#)”.

Revision Status

Revision	Date of Issue	Description
A	April 6, 2011	First Release

CONTENTS

Chapter 1 Disassembly/Reassembly

1.1 Overview	10
1.1.1 Tools	10
1.1.2 Checks and Precautions before Disassembling	10
1.1.3 Protection for Transportation	14
1.1.4 Making a Special Tool for Holder Contact	15
1.1.5 Orientation Definition	16
1.1.6 How to Unlock the Carriage	16
1.2 Disassembly/Reassembly Procedures	17
1.2.1 Overview	17
1.2.2 Disassembly Flowchart	18
1.3 Removing Exterior Parts/Components	24
1.3.1 Printer Cover	24
1.3.2 Paper Support Assy	24
1.3.3 Stacker Assy / Stacker Cover	25
1.3.4 Housing Upper Assy	25
1.4 Removing Control Boards	27
1.4.1 Main Board Unit	27
1.4.2 Panel Assy/ Cover Open Sensor	30
1.4.3 P/S Assy	34
1.5 Disassembling the Printer Mechanism	35
1.5.1 Removing the Printer Mechanism	35
1.5.2 Printhead	37
1.5.3 CR Scale	40
1.5.4 APG Unit	41
1.5.5 Waste Ink Tray	42
1.5.6 Waste Ink Pad Lower / Waste Ink Pad Cap Lower	43
1.5.7 Left & Right Guide Stackers / CDR Guide Sensor	44
1.5.8 Ink System	45
1.5.9 EJ Frame Assy	46
1.5.10 PF Encoder / PF Scale	49
1.5.11 PF Motor	49
1.5.12 CR Motor	50

1.5.13 CR Unit	52
1.5.14 ASF Unit	54
1.5.15 Upper Paper Guide	56
1.5.16 APG Sensor Assy	57
1.5.17 Front Paper Guide Assy	57
1.5.18 CDR Tray Sensor	60
1.6 Disassembling the CISS section	61
1.6.1 Refilling Ink Label / Valve Position Label	61
1.6.2 Top Cover	61
1.6.3 Tube Valve Holder Front / Rear	62
1.6.4 Valve Lever	62
1.6.5 Bottom Cover / Left Cover / Right Cover / Cover Joint	63
1.6.6 Ink Supply Tank Assy	64
1.6.7 Ink Supply Tank Tube Assy	64
1.6.8 Joint	65
1.6.9 Cover Case	65
1.6.10 PF Scale Cover / PF Scale Sheet	66
1.6.11 Tube Guide Sheet / Tube Guide Sheet Sub	66
1.6.12 Ink Supply Tube Assy	67
1.6.13 Adapter Cover	68
1.6.14 Adapter	68

Chapter 2 Adjustment

2.1 Adjustment Items and Overview	70
2.1.1 Servicing Adjustment Item List	70
2.1.2 Required Adjustments	74
2.2 Using the Adjustment Program	77
2.2.1 Top Margin Adjustment	77
2.2.2 Head Angular Adjustment	77
2.2.3 Bi-D Adjustment	78
2.2.4 PW Adjustment/First Dot Position Adjustment	79
2.2.5 PF Adjustment	80
2.2.6 PG Adjustment	81

2.3 Banding Reduction System (BRS) Adjustment / Paper Feed Amount Profile (PFP)	
Correction.....	83
2.3.1 Overview	83
2.3.2 Adjustment Procedure	85

Chapter 3 Maintenance

3.1 Overview	89
3.1.1 Cleaning.....	89
3.1.2 Service Maintenance	89
3.1.3 Lubrication	90

Chapter 4 Appendix

4.1 Power-On Sequence	97
4.2 Standard Operation Time for servicing the product.....	99
4.3 Troubleshooting.....	102
4.3.1 Troubleshooting Workflow	102
4.3.2 Fatal Error Code	104

CHAPTER

1

DISASSEMBLY/REASSEMBLY

1.1 Overview

CHECK
POINT



Some pictures in this manual are for Epson Stylus Photo R280/R285/R290; therefore, the shapes of the parts are different from those of L800/L801, but the differences do not affect the disassembly/reassembly procedures.

This chapter describes procedures for disassembling the main parts/units of L800/L801. Unless otherwise specified, disassembled parts/units can be reassembled by reversing the disassembly procedure. See the cautions or tips for disassembly/reassembly described in “1.2 Disassembly/Reassembly Procedures (p17)”.

Read the following before disassembling and reassembling.

- “Safety Precautions (p3)”
- “1.1.2 Checks and Precautions before Disassembling (p10)”

When you have to remove units or parts that are not described in this chapter, see the exploded diagrams of SPI (Service Parts Information).

1.1.1 Tools

Use only specified tools to avoid damaging the printer.

Table 1-1. List of Tools

Tool	Part No.
Phillips Screwdriver (No.1)	1080530
Phillips Screwdriver (No.2)	---
Flathead Screwdriver	---
Precision Screwdriver #1 (flathead)	---
Tweezers	---
Long-nose pliers	---
Acetate tape	1003963
2 pins (thinner than Ø2 mm)	---
Strong tape	1032813

Note : All of the tools listed above are commercially available. EPSON provides the tools listed with EPSON tool code.

1.1.2 Checks and Precautions before Disassembling

1.1.2.1 Factors which Affect the Print Quality

HOW TO PLACE THE INK TANK ASSY WHEN DISASSEMBLING/REASSEMBLING

The film under sealing film attached on the Ink Supply Tank Assy of this printer is ventilation film. The ink in the ink tanks is vented to atmosphere through this film to keep ink supply to the Printhead stable. If the film gets wet with ink, the ink in the tanks is not properly vented and printing may not be capable.

In order to prevent this from occurring, make sure to place the Ink Supply Tank Assy as shown below after removing it.

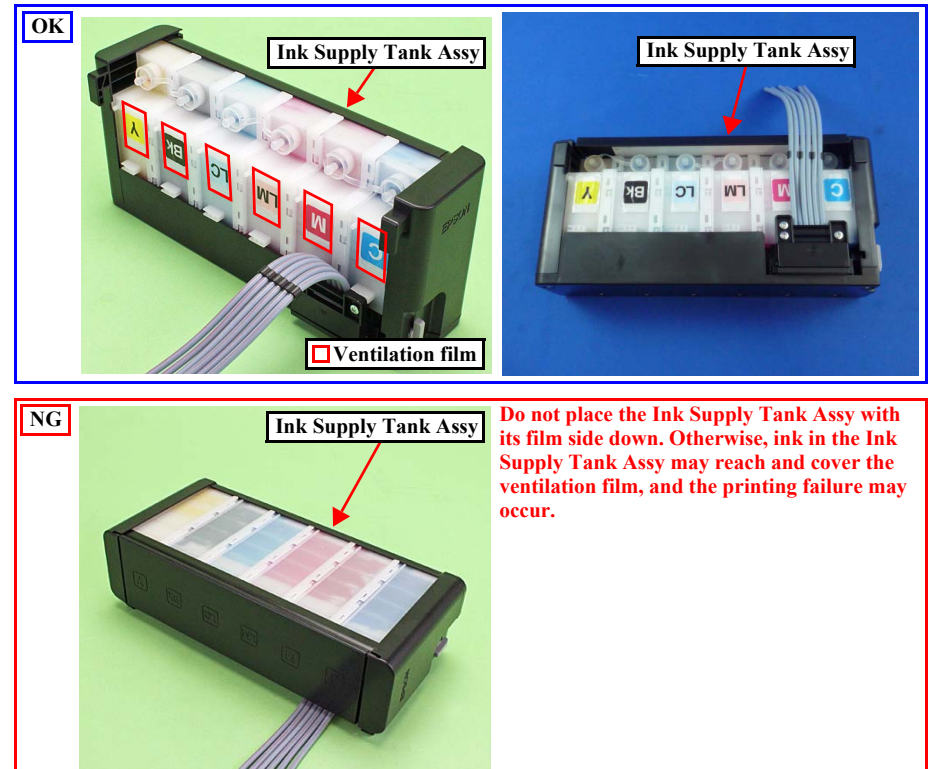

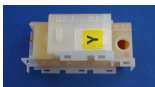

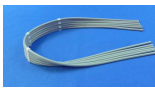

Figure 1-1. How to Place the Ink Tank Assy

1.1.2.2 Factors which Affect the Safety of Service Personnel such as Ink Leakage during Operation

Ink may spill when removing the following parts from L800/L801. This section describes the parts that may cause ink spill and the means to minimize the ink spill when removing the parts.

THE PARTS THAT MAY CAUSE INK SPILL WHEN REMOVING

Parts	When ink may spill	Location
 Joint	Removing the Ink Supply Tank Tube Assy / Ink Supply Tube Assy from the Joint	A
 Ink Supply Tank Assy	<input type="checkbox"/> Removing the tubes of the Ink Supply Tank Tube Assy from the Joint <input type="checkbox"/> Removing the tubes of the Ink Supply Tank Tube Assy from the Ink Supply Tank Assy	A, B
 Ink Supply Tank Tube Assy (w/Valve Assy)		
 Adapter	Removing the Ink Supply Tube Assy from the Adapter	C
 Ink Supply Tube Assy	<input type="checkbox"/> Removing the Ink Supply Tank Tube Assy / Ink Supply Tube Assy from the Joint <input type="checkbox"/> Removing the Ink Supply Tube Assy from the Adapter	A, C

Note : These parts are indicated with the  icon in disassembly/reassembly flowchart. (See “1.2 Disassembly/Reassembly Procedures (p17)”.)

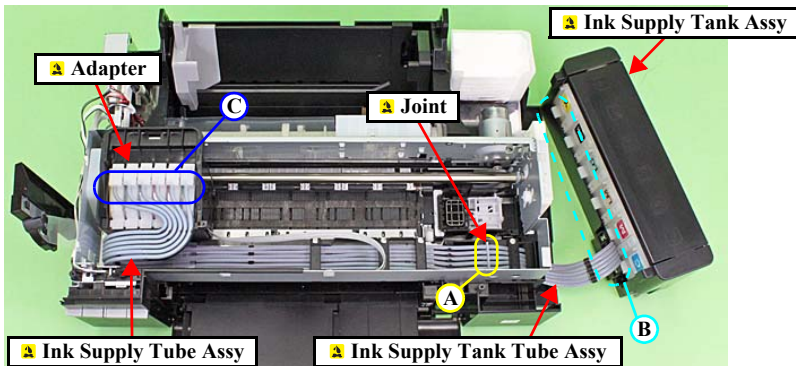

Figure 1-2. Location

MEANS DO TO MINIMIZE THE INK SPILL



Even observing the points described in this section, ink may spill in the following situations. Therefore, be careful not to contaminate the inside of the printer or its surroundings by preparing the container to receive the leaked ink, or the like.

- When removing the Ink Supply Tank Tube Assy (w/ Valve Assy), some ink will spill from both ends of the tube even the Valve Lever is closed.
- When removing the Ink Supply Tube Assy, all the ink in the tube will spill.

Before disassembling, confirm that the printer is in the following condition.

- Choke Valve is closed



Do not turn the Valve Lever too much when closing the Choke Valve, otherwise, the Valve Lever and/or Valve Assy may get damaged.

- Before disassembling:
Turn the Valve Lever and be sure to close the Choke Valve.
- After reassembling is complete:
Open the Choke Valve to perform the print inspection.
- Before returning the printer to the user after repairing:
Make sure to turn the Valve Lever up to the choke position to close the Choke Valve before packing the printer.

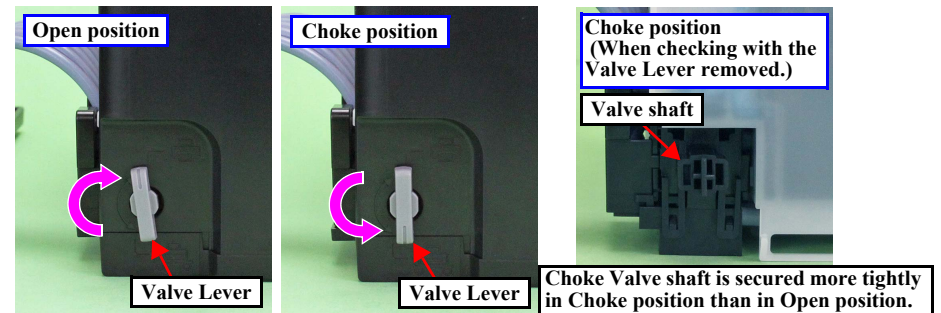

Figure 1-3. Opening/closing the Choke Valve

- Adapter is removed

Before disconnecting the joint parts of the ink path, make sure that the Adapter is removed from the Carriage.

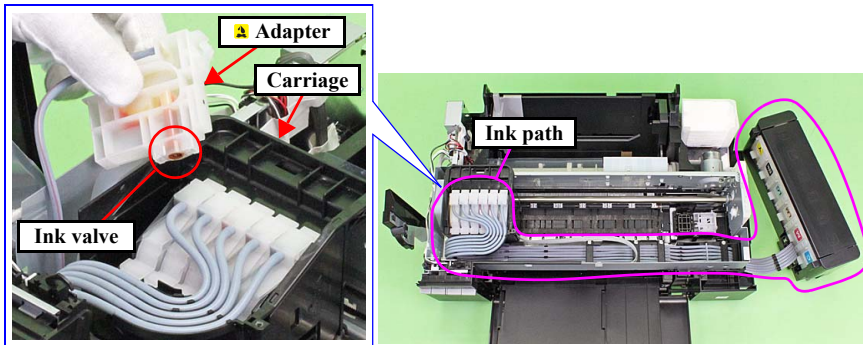

Figure 1-4. Adapter

CHECK
POINT



The Adapter has an ink valve which cuts off the ink path when removing the Adapter from the Carriage.

DISCHRGING INK FROM THE INK SUPPLY TANK

Discharging ink is recommended only when disconnecting the Ink Supply Tank Tube Assy from the Ink Supply Tank. Before performing the above disconnection, discharge ink from the Ink Supply Tank as follows.

- Necessary tools
 - Containers (x 6) for each discharged ink
 - Injector (with a tip of $\phi 3.2$ mm)
 - Tube (capable to be connected to the joint)

CHECK
POINT



- The photos in the following procedure are for L200/L201, but the procedure for L800/L801 is the same; the numbers of the tube and the location of the Ink Supply Tank Assy in the photos are different from those of L800/L801, though.
- Prior to the following steps, connect the injector with the tube, and then discharge ink according to the procedure.

- Discharging procedure
 1. Remove the Housing Upper Assy. (p.25)
 2. With the choke value closed (p.11), place the Ink Supply Tank Assy on a place where its bottom is higher than the top of the Printhead.
 3. Prepare a container for ink to discharge, then disconnect the Ink Supply Tube from the joint and put its tip into the container for the ink.
 4. Open the choke valve to discharge the ink in the Ink Supply Tank Assy to the container.

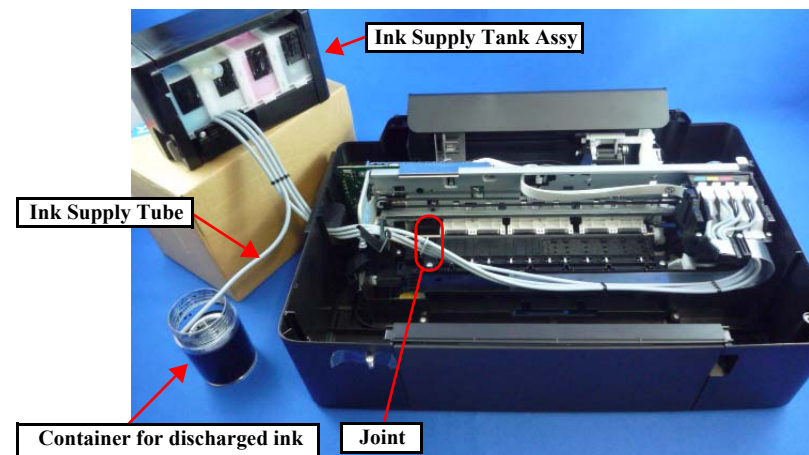

Figure 1-5. Discharging Ink (1)

5. When the ink stops flowing from the tube, close the choke valve, and then connect the Ink Supply Tube back to the joint.
6. Disconnect the Ink Supply Tube of the same color connected to the opposite side of the joint.
7. Connect the tube from the injector.
8. Open the choke valve again, and suck up the remaining ink in the Ink Supply Tank into the injector.
9. Disconnect the tube from the injector, and connect the Ink Supply Tube of the same color back to the joint.

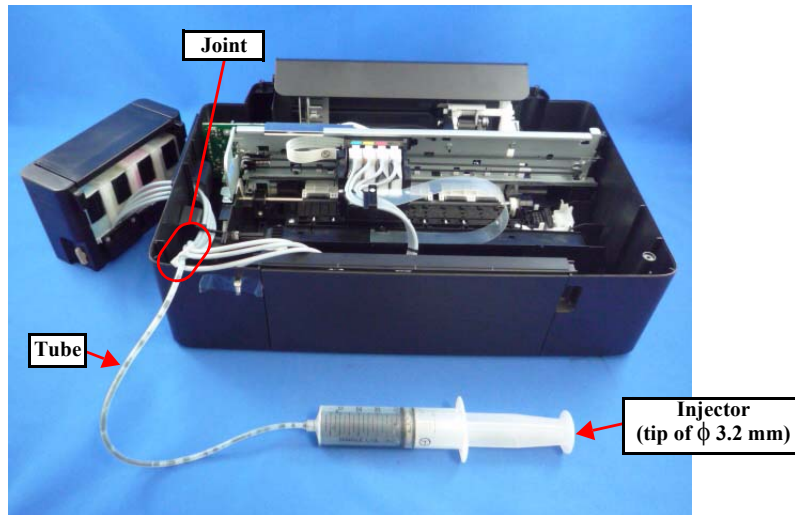

Figure 1-6. Discharging Ink (2)

10. Repeat Step 3 to Step 10 for all ink tanks to discharge all ink in the Ink Supply Tank.

CHECK
POINT



- It is recommended that the ink in the Ink Supply Tank should be discharged completely before proceeding to disassembling/reassembling.
- After all the reassembling work is complete, the discharged ink of each color should be refilled back to the Ink Supply Tank before performing the adjustment. Confirm the colors indicated on the film of the Ink Supply Tank so as not to mistake them, and make sure to refill each ink back to the correct tank from the corresponding ink supply hole.

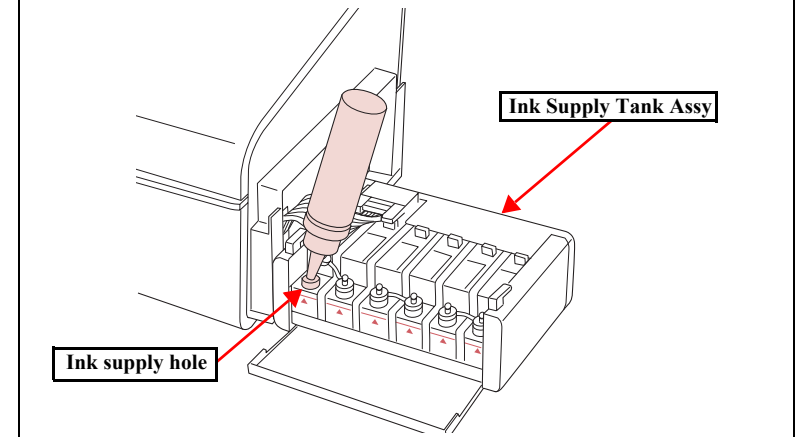

1.1.3 Protection for Transportation

Before packing the printer for returning it to the user, secure it at the specified points with strong tape to avoid damaging the printer or ink leakage during transport, and make sure to check the points as follows.

□ Attaching the Air Release Hole Caps

- To prevent the ventilation film from getting wet, attach the Air Release Hole Caps (part number: 1556135) to the air release holes of the Ink Supply Tank Assy.

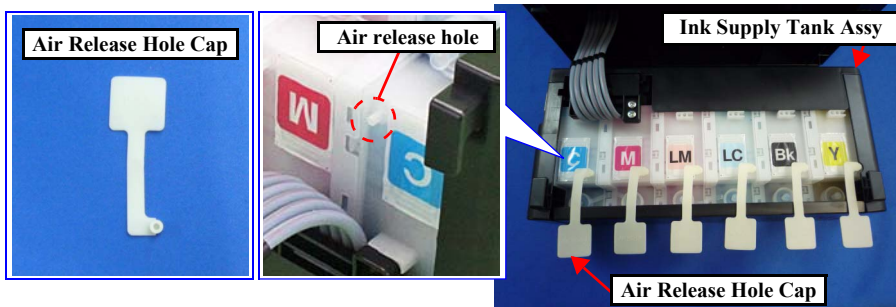

Figure 1-7. Attaching the Air Release Hole Caps

□ Securing each parts

Secure the following parts with strong tape (width: 22 mm).

- Securing the CR Unit
 1. Confirm that the CR Unit is locked in the home position.
 2. Attach the unfolded end of strong tape (fold the other end back 10 mm) on the bottom left of the Adapter Cover.
 3. Pull the tape to the right side of the housing and attach it tightly.

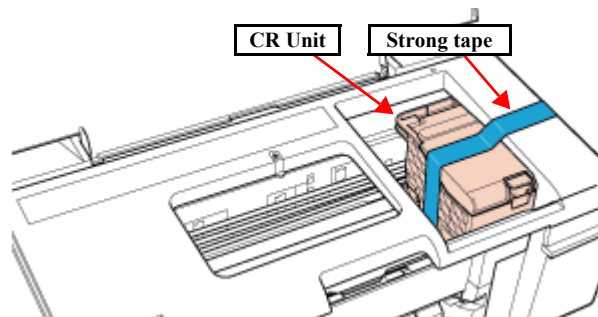

Figure 1-8. Securing the CR Unit

■ Securing the Ink Tank

- Secure both sides of the Top Cover with strong tape (x2).
- Align the unfolded end of strong tape (x5) with the edge of the Housing Upper, and attach the tape along the shape of the Housing Upper/Ink Supply Tank Assy through the openings between the Air Release Hole Caps.

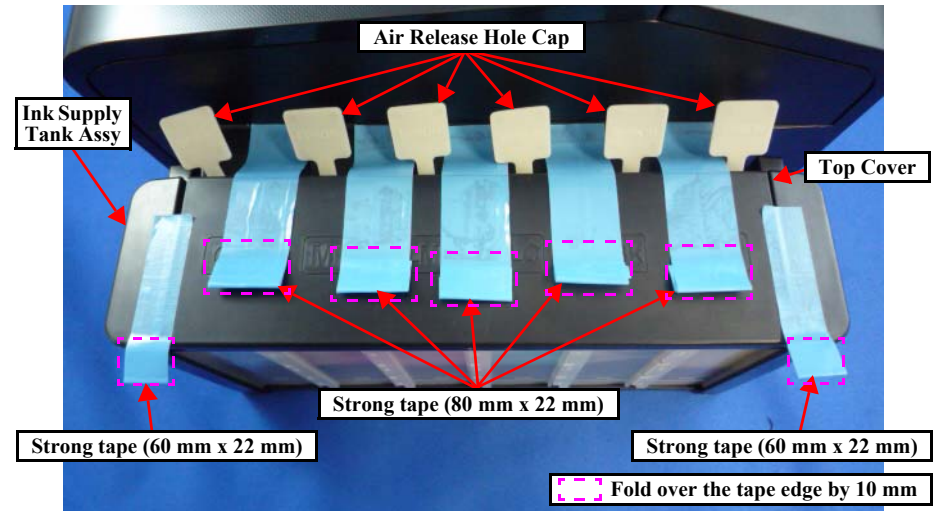
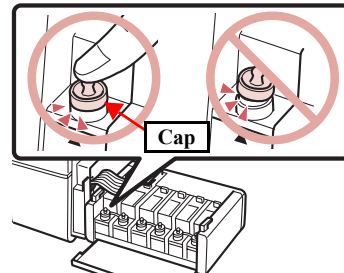
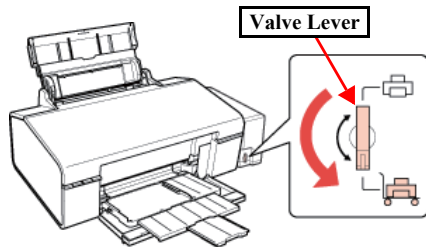

Figure 1-9. Securing the Ink Supply Tank Assy

□ Points to be checked before packing the printer

- The Valve Lever is on the position shown below (the Choke Valve is closed). (See [Figure 1-3](#).)
- All the caps of the Ink Supply Tank Assy are securely closed.



- The hooks (x2) of the Ink Supply Tank Assy are securely engaged with the Housing Upper Assy.
- The opened ink bottle is not included in the box.

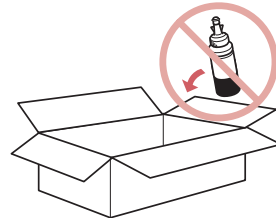
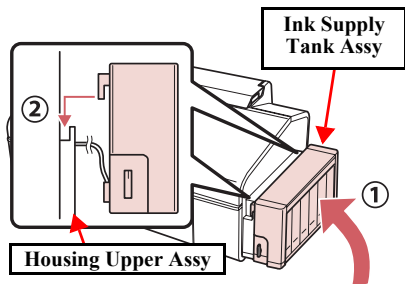

1.1.4 Making a Special Tool for Holder Contact

The Holder Contact (refer to [p.38](#)) can be easily removed by using a special tool. The method for making the tool is described below.

1. Prepare a handle part of a clip, or a similar metal wire piece.

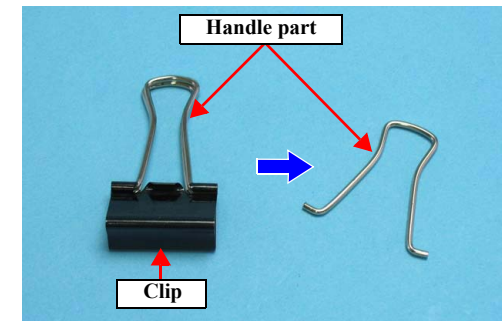

Figure 1-10. Making Special Tool for Holder Contact (1)

2. Bend the metal wire as shown below.

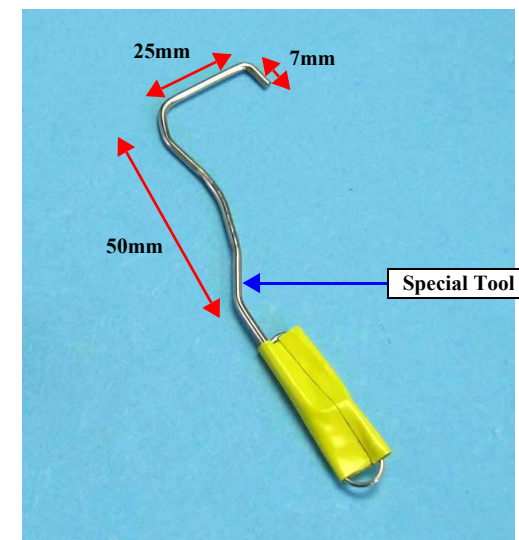

Figure 1-11. Making Special Tool for Holder Contact (2)

1.1.5 Orientation Definition

Orientation descriptions used in the disassembly/reassembly procedures are as follows.

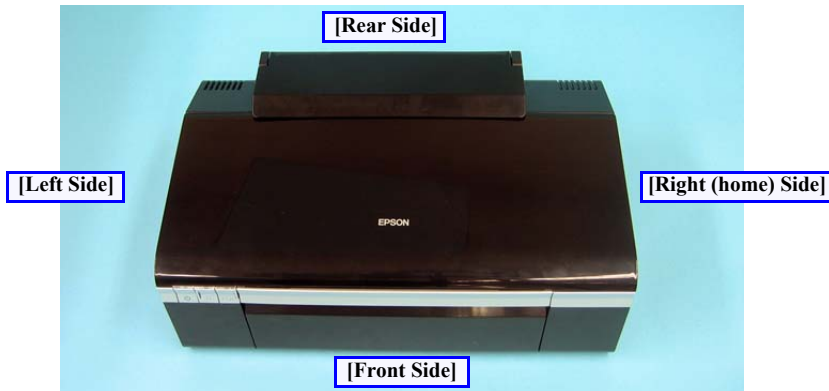

Figure 1-12. Orientation Definition

1.1.6 How to Unlock the Carriage

Unlocking the carriage is required for disassembly of some parts or components. Carry out any of the following operations to unlock the carriage and move the carriage to other than its home position.

CAUTION



Be extremely careful not to damage the EJ Roller gear. Extra care must be taken to avoid injury from sharp metal edges.

- Power the printer and turn it off forcibly by disconnecting the power cable when the CR Unit is unlocked and moved away from the home position.
- Turn the EJ Roller gear on the left side of the printer in the direction of the arrow until the carriage is unlocked.

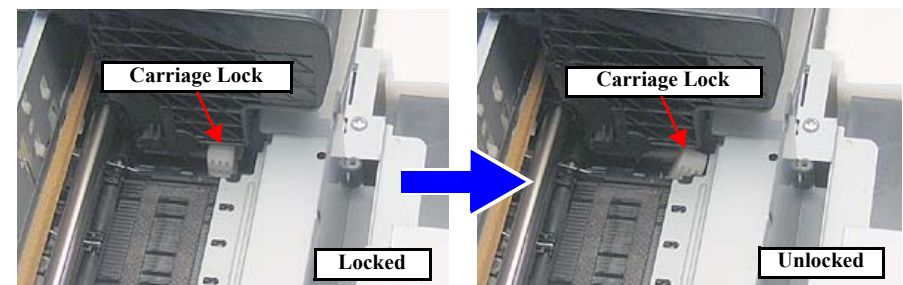
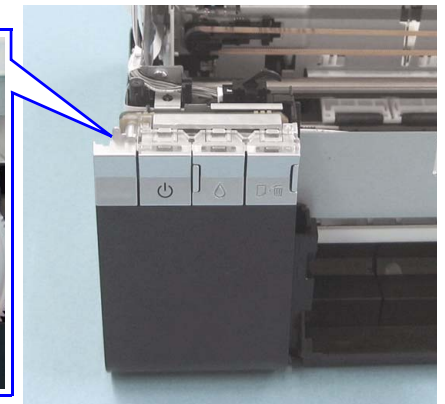
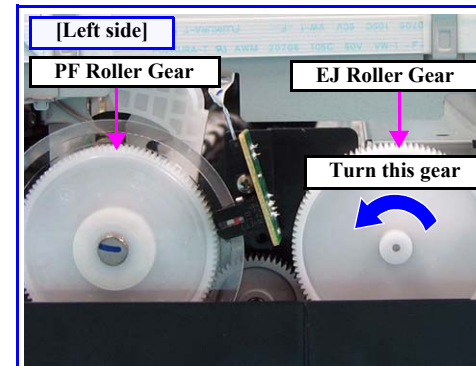

Figure 1-13. How to Unlock the Carriage

1.2 Disassembly/Reassembly Procedures

1.2.1 Overview

This section describes procedures for disassembling the parts/units in a flowchart format. For some parts/units, detailed procedures or precautions are provided (accordingly indicated by icons and cell's color). Refer to the explanations in the example chart below and perform an appropriate disassembling and reassembling procedure. (See “ 1.3 Removing Exterior Parts/Components (p24)”.)

The example below shows how to see the charts on the following pages.

Table 1-2. Explanatory Note

Item	Description	Reference
Parts/unit name	White-letter	Parts/units supplied as an ASP
	Black-letter	Parts/units not supplied as an ASP
Icon		Indicates a practice or condition that could result in injury or loss of life if not strictly observed.
		Indicates a practice or condition that could result in damage to, or destruction of equipment if not strictly observed.
		Indicates the parts that are inevitably broken in the disassembling procedure, and should be replaced with a new one for reassembly.
		Indicates the parts that may cause the ink spill when they are removed.
		Indicates necessary check items in the disassembling/reassembling procedure.
		Indicates supplementary explanation for disassembly is given.
		Indicates particular tasks to keep quality of the units are required.
		Indicates particular adjustment(s) is/are required.
		Indicates lubrication is required.
		Indicates the number of screws securing the parts/units.
	Indicates the points secured with other than a screw such as a hook, rib, dowel or the like.	

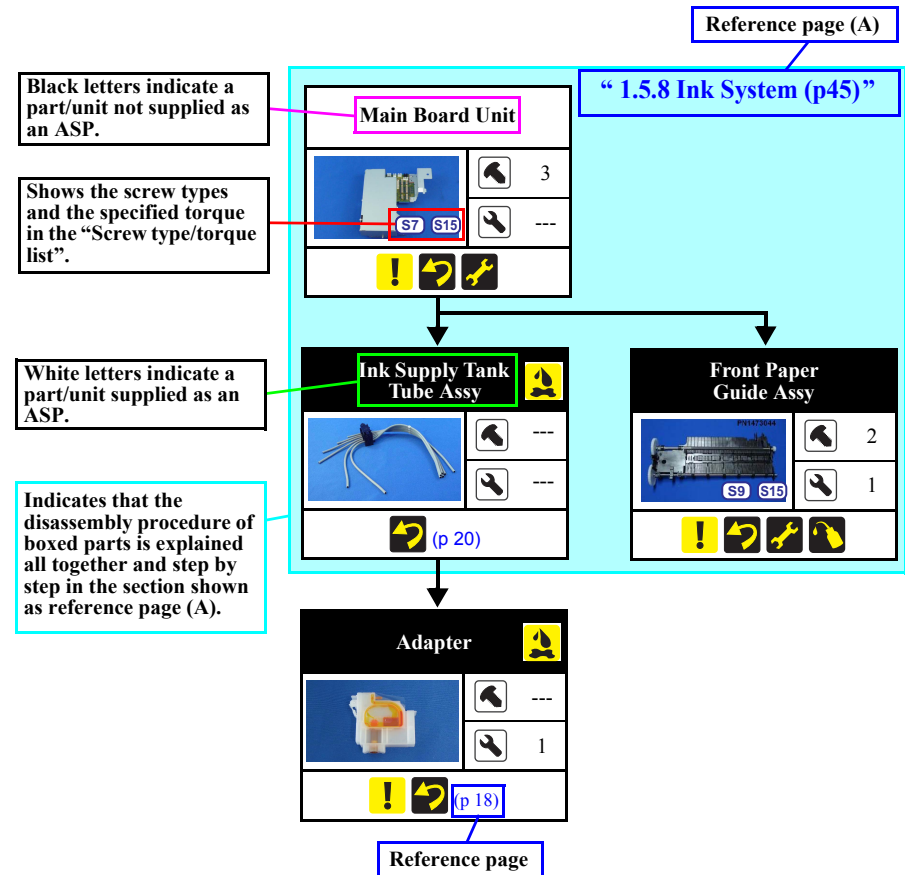
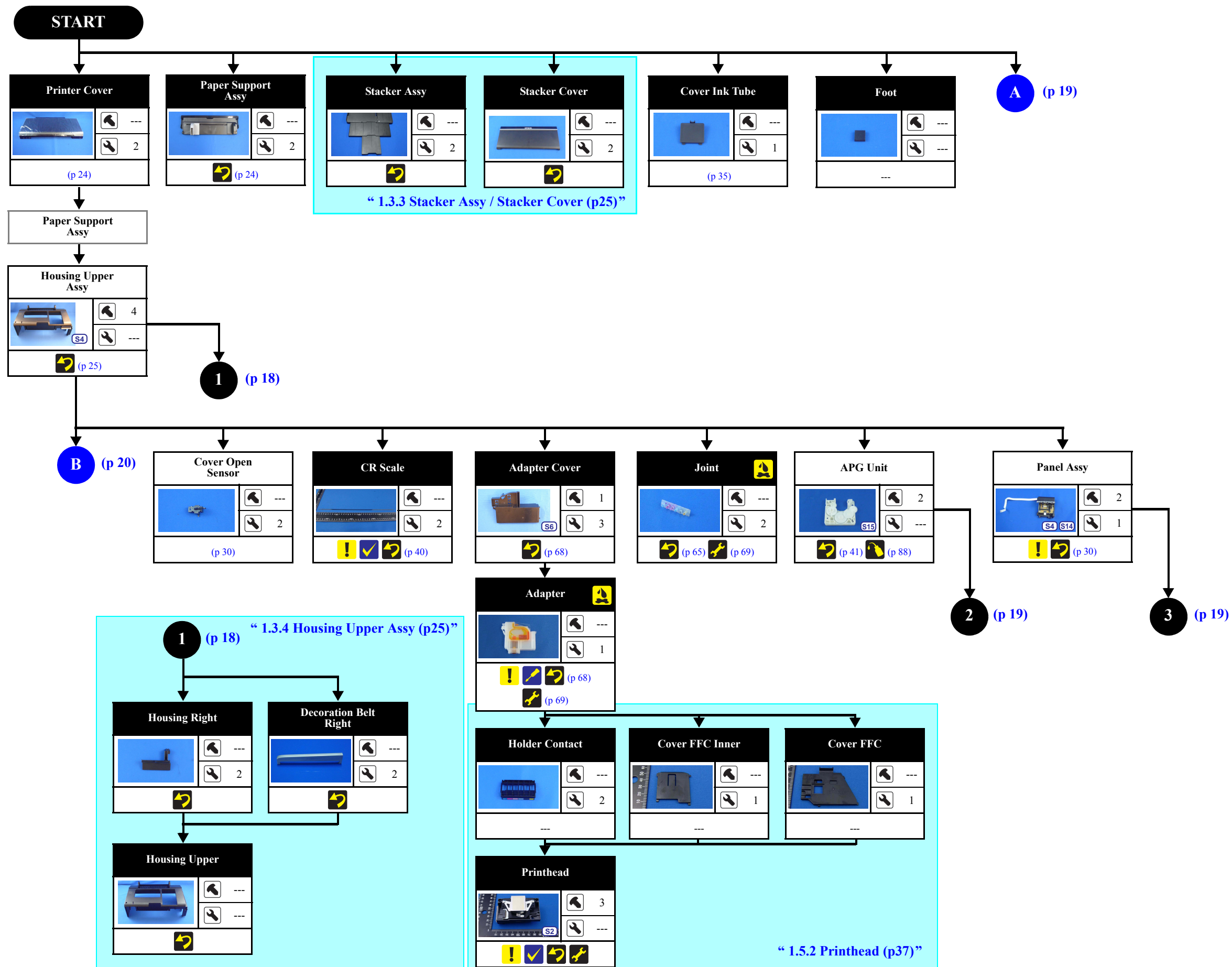

Figure 1-14. Example Chart

1.2.2 Disassembly Flowchart



Screw type/torque list

Symbol	Screw type	Torque
(S1)	C.B.P. 2.6X8	3.5-4.5kgf.cm
(S2)	C.B.P. 2.6X8	3-5kgf.cm
(S3)	C.B.P. 3X10	3-5kgf.cm
(S4)	C.B.P. 3X10	5-7kgf.cm
(S5)	C.B.P. 3X6	3-5kgf.cm
(S6)	C.B.P. 3X8	5-7kgf.cm
(S7)	C.B.P.(P2) 3X8	5-7kgf.cm
(S8)	C.B.S 3X6	5-7kgf.cm
(S9)	C.B.S. (P2) 3X8	6-8kgf.cm
(S10)	C.B.S. (P4) 3X6	7-9kgf.cm
(S11)	C.B.S. (P4) 3X6	9-11kgf.cm
(S12)	C.B.S. 3X10	4-6kgf.cm
(S13)	C.B.S. 3X6	4-6kgf.cm
(S14)	C.B.S. 3X6	5-7kgf.cm
(S15)	C.B.S. 3X6	7-9kgf.cm
(S16)	C.P. 3X4	3-5kgf.cm
(S17)	C.P. 3X6	3-5kgf.cm
(S18)	C.P. 3X6	4-6kgf.cm

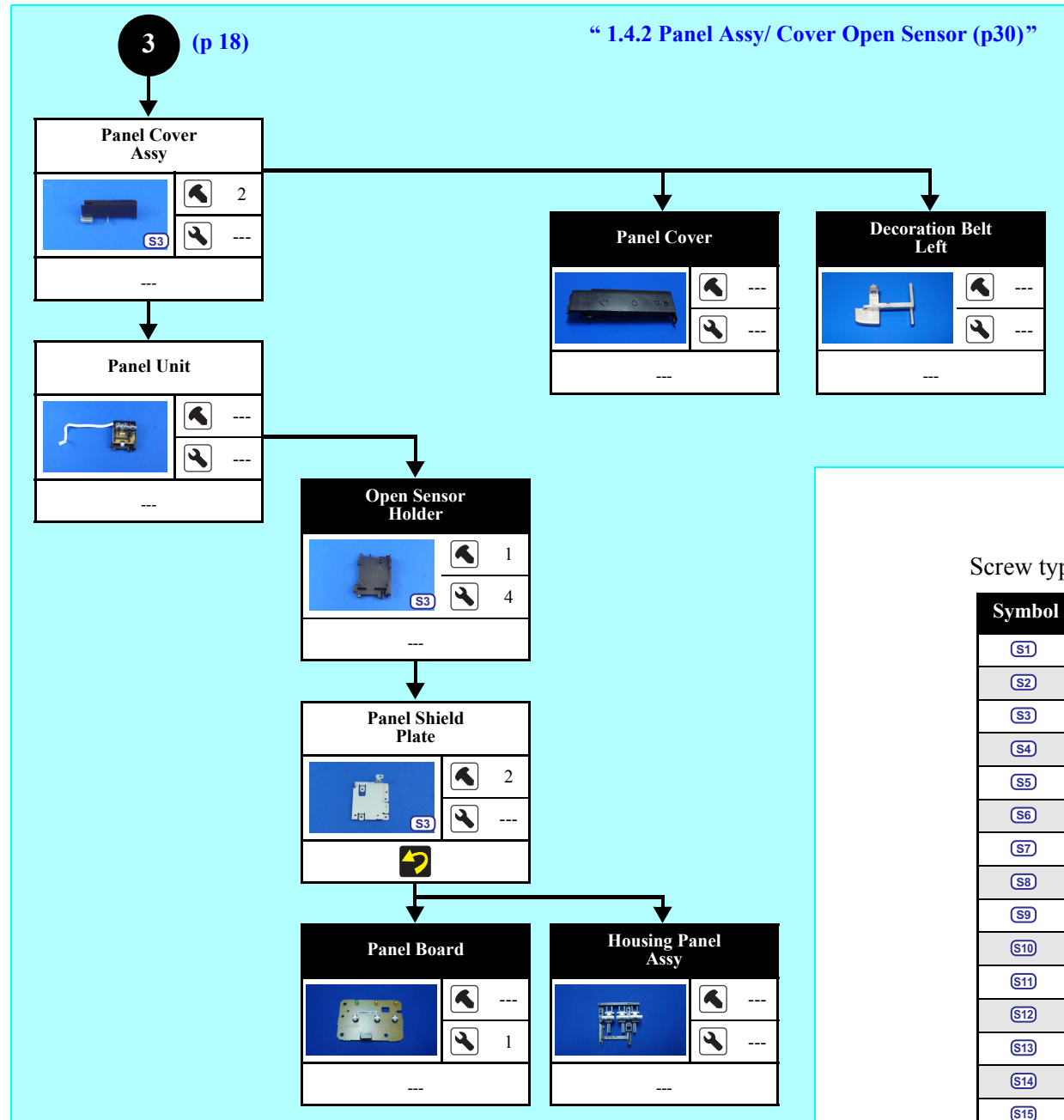
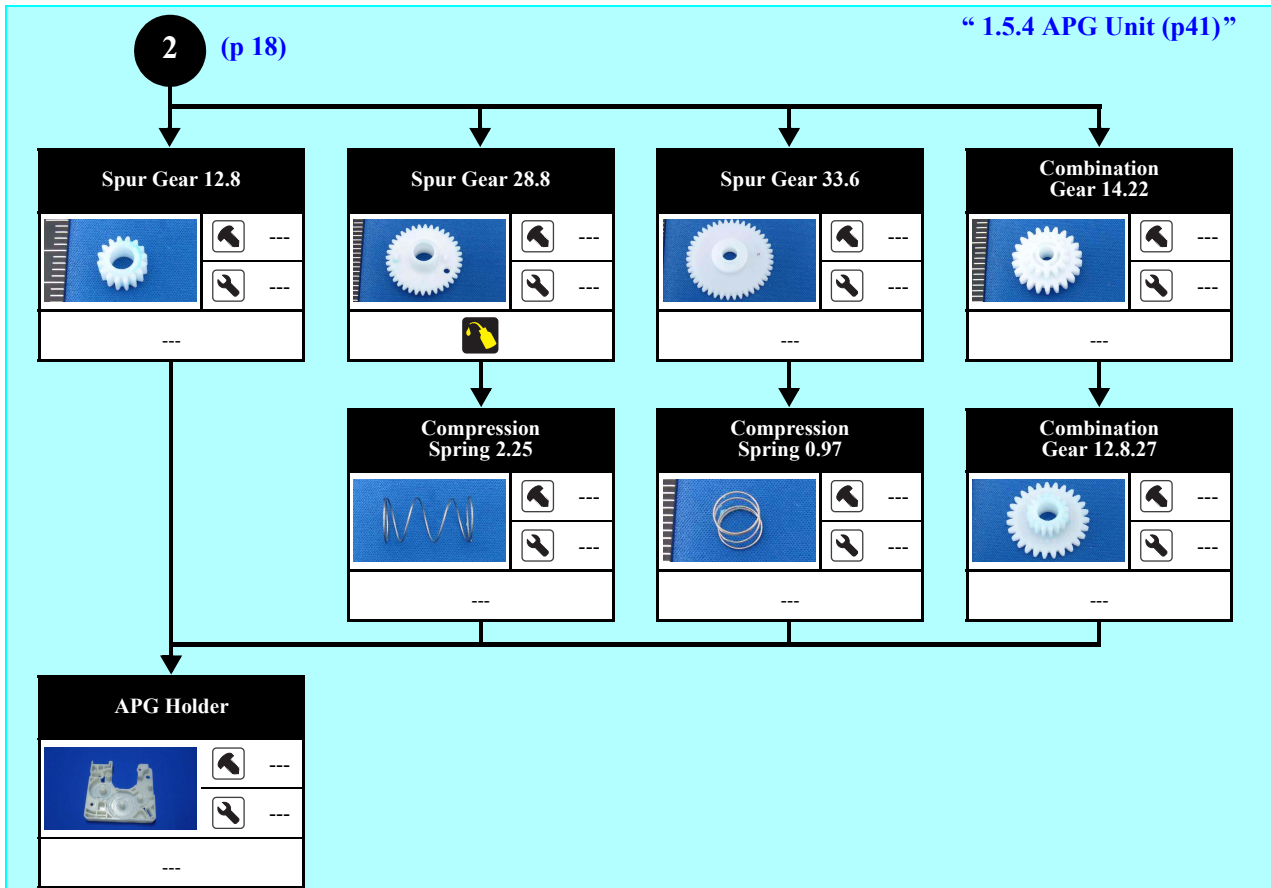
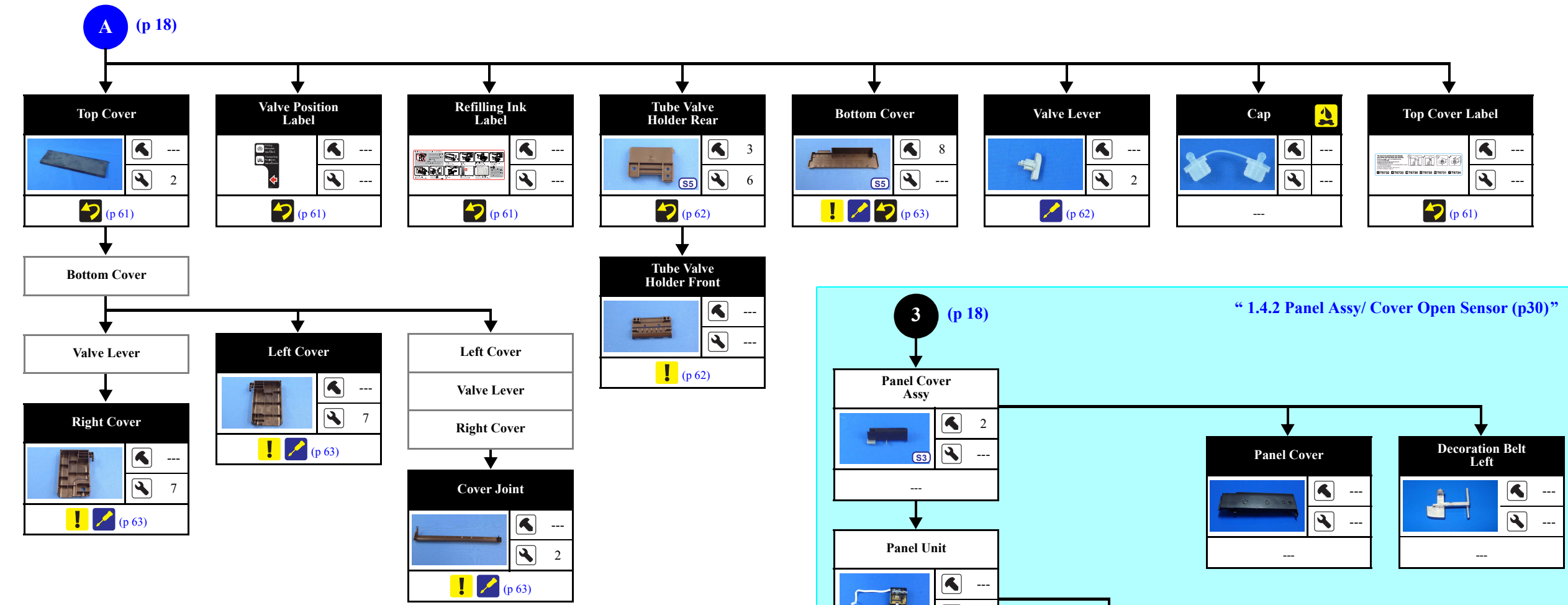

Screw type/torque list

Symbol	Screw type	Torque
(S1)	C.B.P. 2.6X8	3.5-4.5kgf.cm
(S2)	C.B.P. 2.6X8	3-5kgf.cm
(S3)	C.B.P. 3X10	3-5kgf.cm
(S4)	C.B.P. 3X10	5-7kgf.cm
(S5)	C.B.P. 3X6	3-5kgf.cm
(S6)	C.B.P. 3X8	5-7kgf.cm
(S7)	C.B.P.(P2) 3X8	5-7kgf.cm
(S8)	C.B.S 3X6	5-7kgf.cm
(S9)	C.B.S. (P2) 3X8	6-8kgf.cm
(S10)	C.B.S. (P4) 3X6	7-9kgf.cm
(S11)	C.B.S. (P4) 3X6	9-11kgf.cm
(S12)	C.B.S. 3X10	4-6kgf.cm
(S13)	C.B.S. 3X6	4-6kgf.cm
(S14)	C.B.S. 3X6	5-7kgf.cm
(S15)	C.B.S. 3X6	7-9kgf.cm
(S16)	C.P. 3X4	3-5kgf.cm
(S17)	C.P. 3X6	3-5kgf.cm
(S18)	C.P. 3X6	4-6kgf.cm

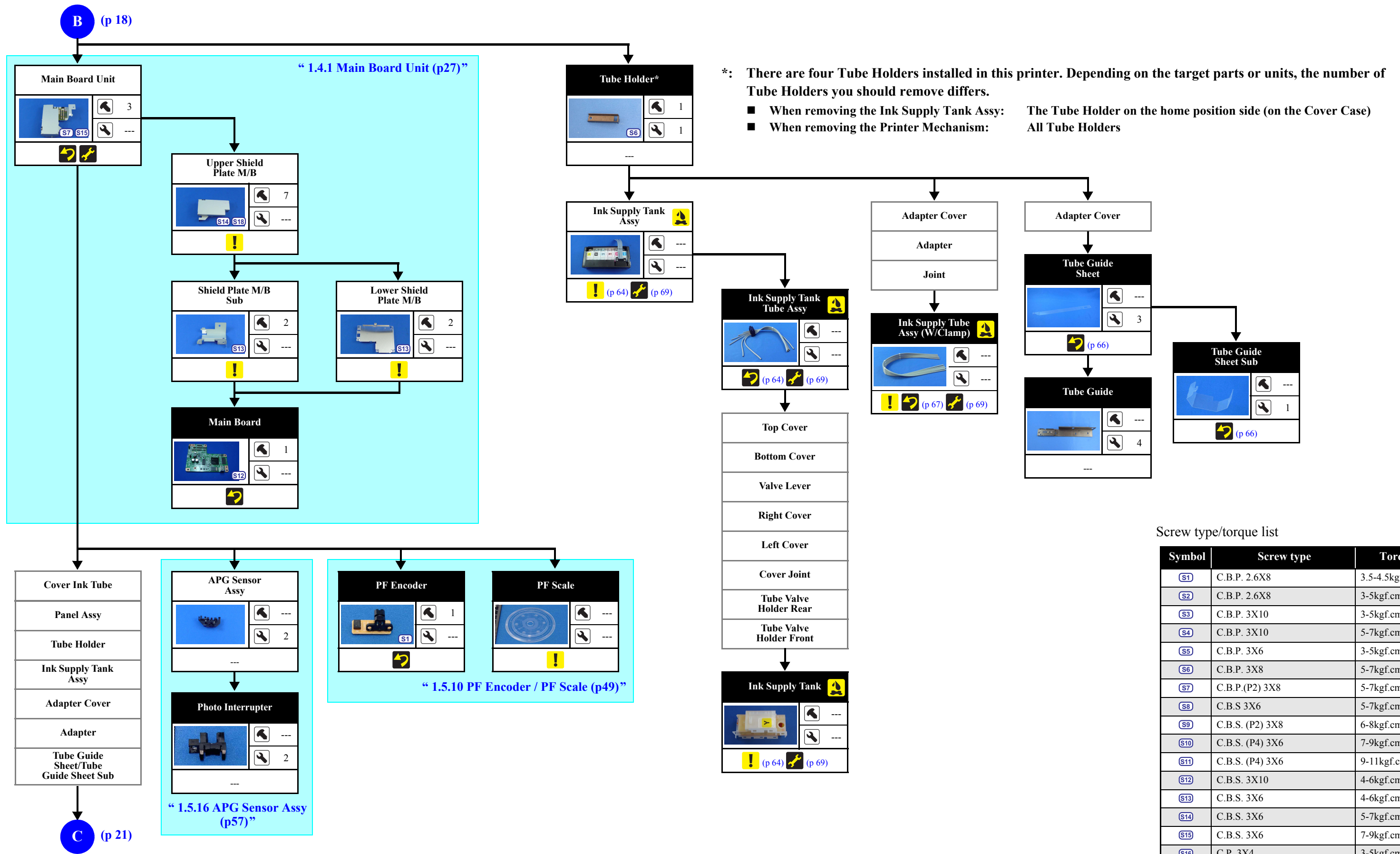

Screw type/torque list

Symbol	Screw type	Torque
S1	C.B.P. 2.6X8	3.5-4.5kgf.cm
S2	C.B.P. 2.6X8	3-5kgf.cm
S3	C.B.P. 3X10	3-5kgf.cm
S4	C.B.P. 3X10	5-7kgf.cm
S5	C.B.P. 3X6	3-5kgf.cm
S6	C.B.P. 3X8	5-7kgf.cm
S7	C.B.P.(P2) 3X8	5-7kgf.cm
S8	C.B.S 3X6	5-7kgf.cm
S9	C.B.S. (P2) 3X8	6-8kgf.cm
S10	C.B.S. (P4) 3X6	7-9kgf.cm
S11	C.B.S. (P4) 3X6	9-11kgf.cm
S12	C.B.S. 3X10	4-6kgf.cm
S13	C.B.S. 3X6	4-6kgf.cm
S14	C.B.S. 3X6	5-7kgf.cm
S15	C.B.S. 3X6	7-9kgf.cm
S16	C.P. 3X4	3-5kgf.cm
S17	C.P. 3X6	3-5kgf.cm
S18	C.P. 3X6	4-6kgf.cm

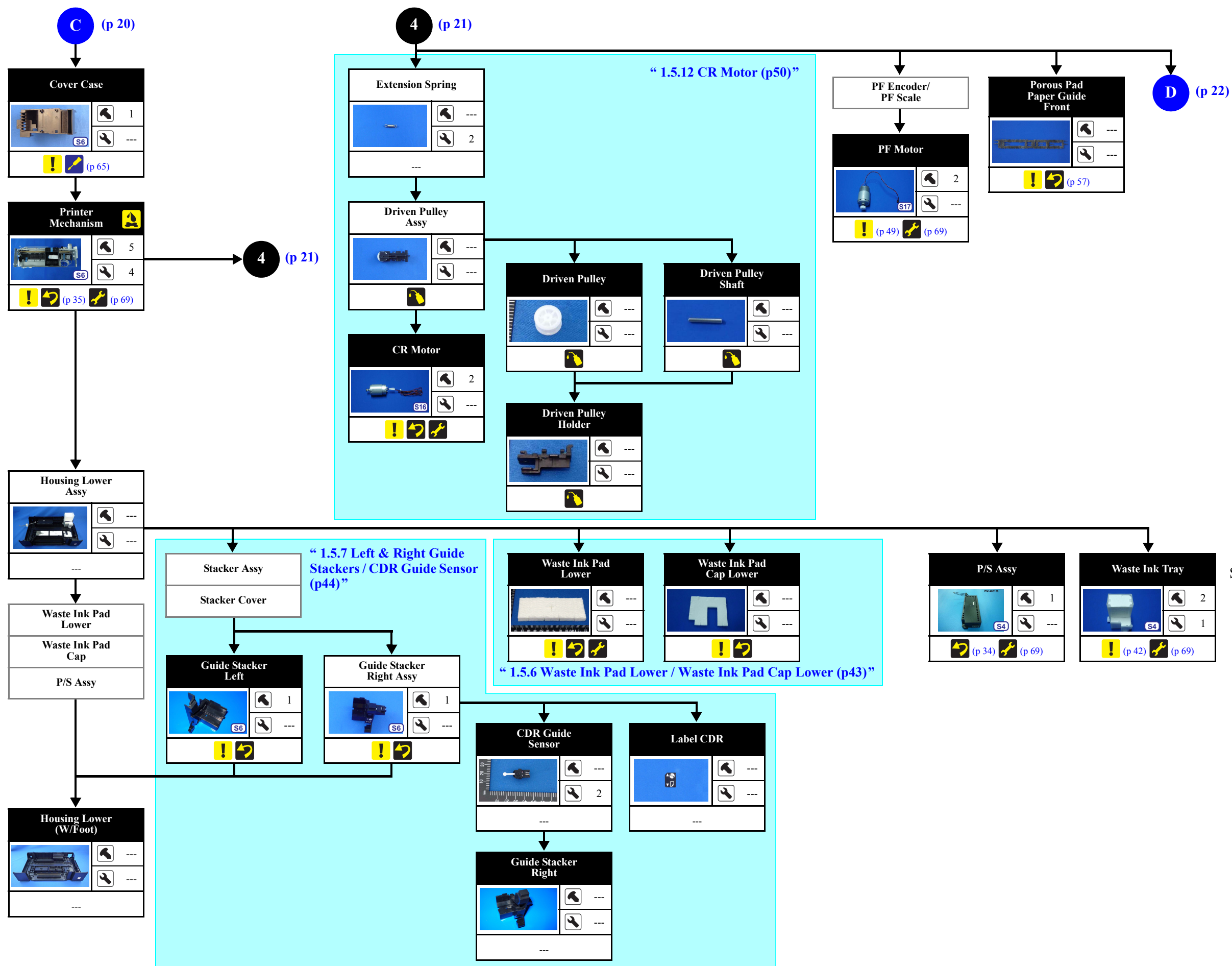

Screw type/torque list

Symbol	Screw type	Torque
(S1)	C.B.P. 2.6X8	3.5-4.5kgf.cm
(S2)	C.B.P. 2.6X8	3-5kgf.cm
(S3)	C.B.P. 3X10	3-5kgf.cm
(S4)	C.B.P. 3X10	5-7kgf.cm
(S5)	C.B.P. 3X6	3-5kgf.cm
(S6)	C.B.P. 3X8	5-7kgf.cm
(S7)	C.B.P.(P2) 3X8	5-7kgf.cm
(S8)	C.B.S 3X6	5-7kgf.cm
(S9)	C.B.S. (P2) 3X8	6-8kgf.cm
(S10)	C.B.S. (P4) 3X6	7-9kgf.cm
(S11)	C.B.S. (P4) 3X6	9-11kgf.cm
(S12)	C.B.S. 3X10	4-6kgf.cm
(S13)	C.B.S. 3X6	4-6kgf.cm
(S14)	C.B.S. 3X6	5-7kgf.cm
(S15)	C.B.S. 3X6	7-9kgf.cm
(S16)	C.P. 3X4	3-5kgf.cm
(S17)	C.P. 3X6	3-5kgf.cm
(S18)	C.P. 3X6	4-6kgf.cm

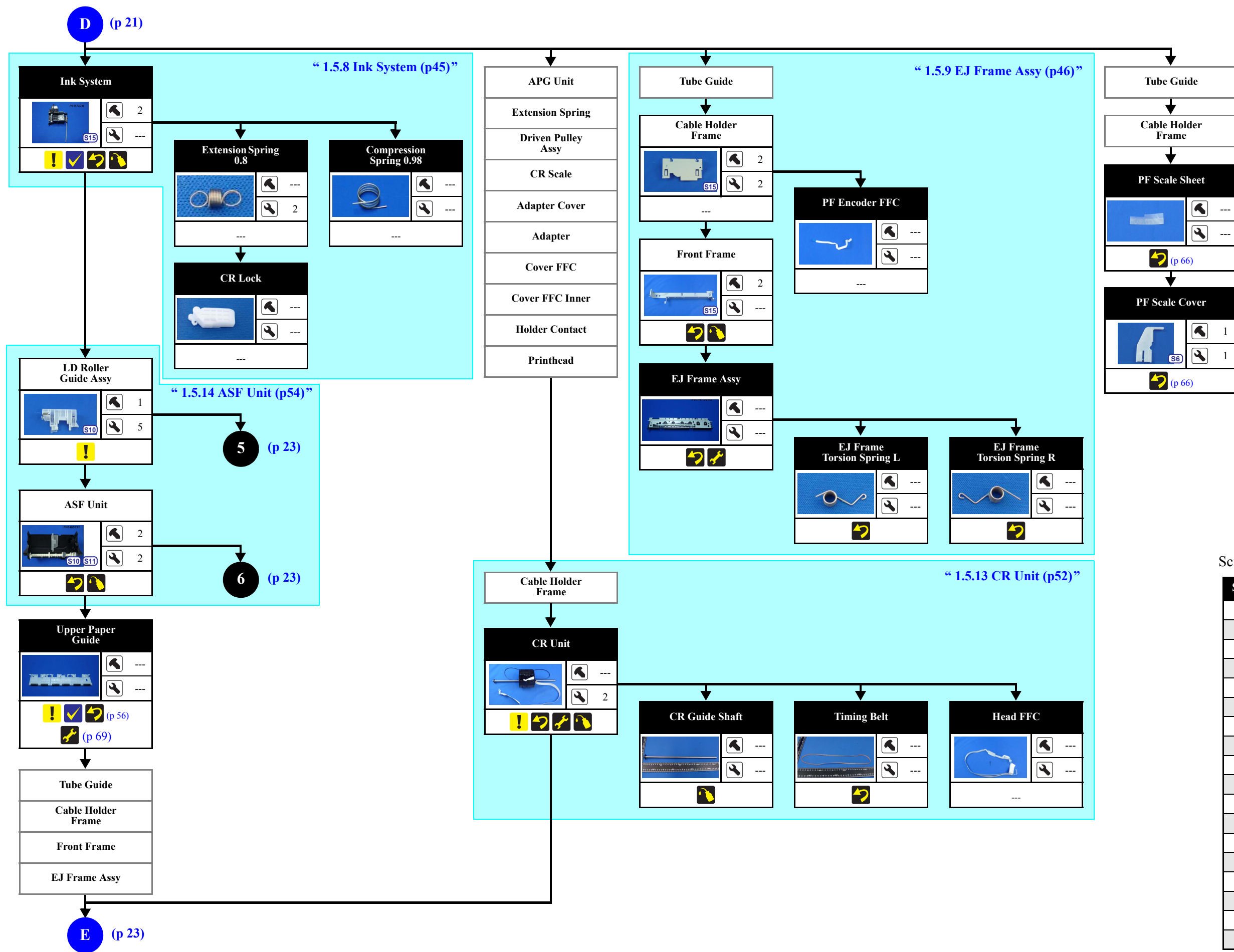

Screw type/torque list

Symbol	Screw type	Torque
S1	C.B.P. 2.6X8	3.5-4.5kgf.cm
S2	C.B.P. 2.6X8	3-5kgf.cm
S3	C.B.P. 3X10	3-5kgf.cm
S4	C.B.P. 3X10	5-7kgf.cm
S5	C.B.P. 3X6	3-5kgf.cm
S6	C.B.P. 3X8	5-7kgf.cm
S7	C.B.P.(P2) 3X8	5-7kgf.cm
S8	C.B.S 3X6	5-7kgf.cm
S9	C.B.S. (P2) 3X8	6-8kgf.cm
S10	C.B.S. (P4) 3X6	7-9kgf.cm
S11	C.B.S. (P4) 3X6	9-11kgf.cm
S12	C.B.S. 3X10	4-6kgf.cm
S13	C.B.S. 3X6	4-6kgf.cm
S14	C.B.S. 3X6	5-7kgf.cm
S15	C.B.S. 3X6	7-9kgf.cm
S16	C.P. 3X4	3-5kgf.cm
S17	C.P. 3X6	3-5kgf.cm
S18	C.P. 3X6	4-6kgf.cm

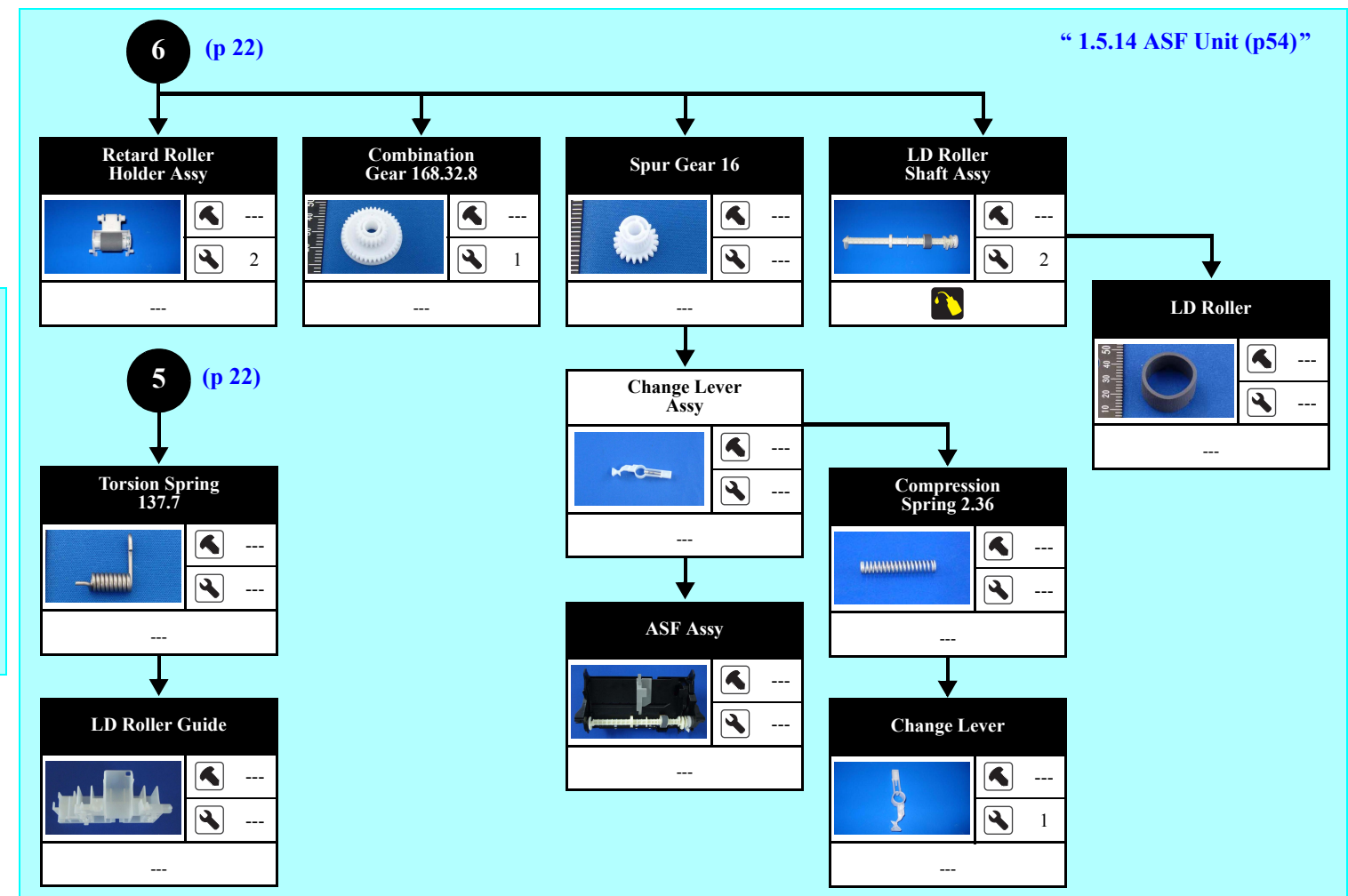
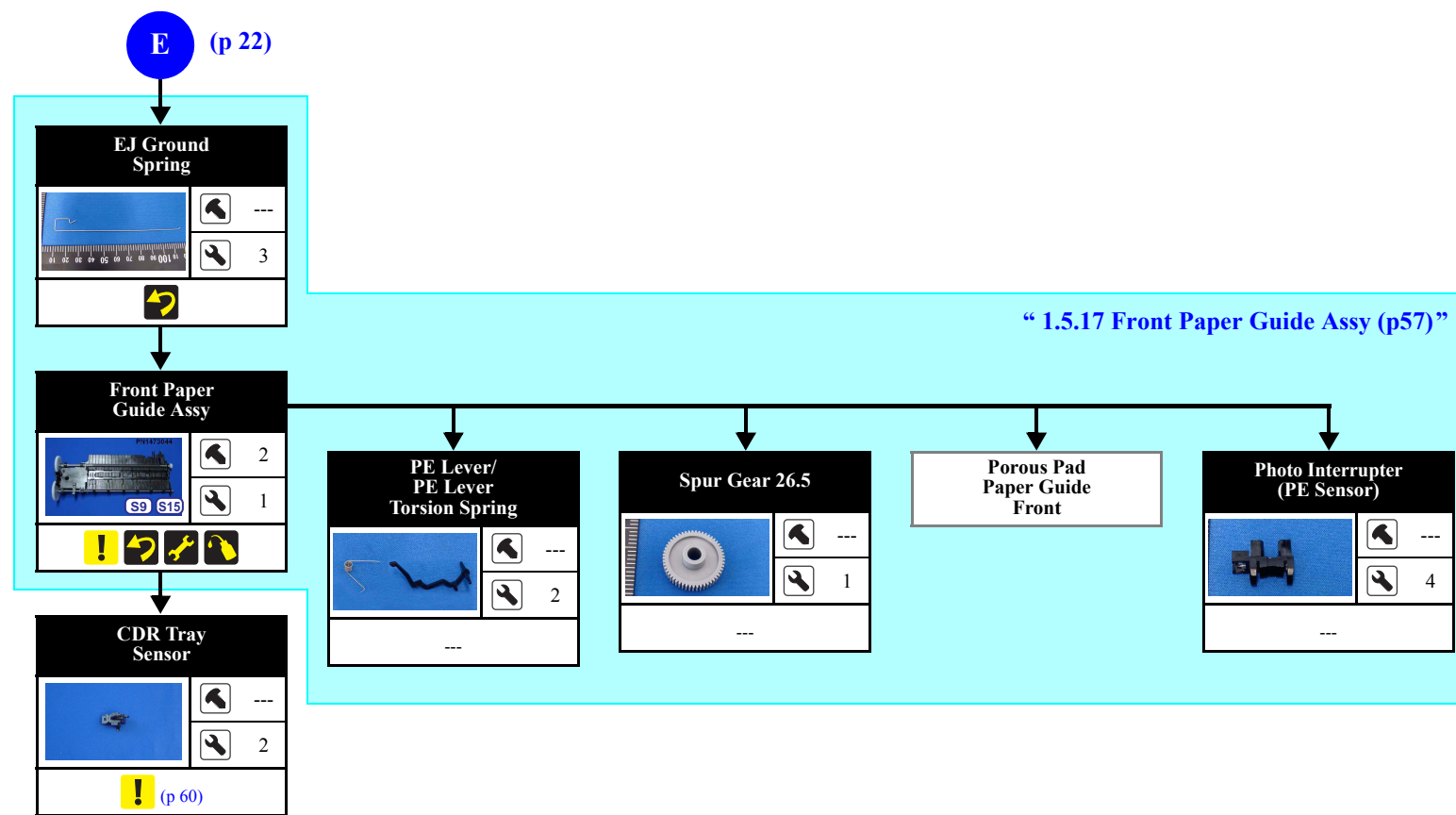

Screw type/torque list

Symbol	Screw type	Torque
S1	C.B.P. 2.6X8	3.5-4.5kgf.cm
S2	C.B.P. 2.6X8	3-5kgf.cm
S3	C.B.P. 3X10	3-5kgf.cm
S4	C.B.P. 3X10	5-7kgf.cm
S5	C.B.P. 3X6	3-5kgf.cm
S6	C.B.P. 3X8	5-7kgf.cm
S7	C.B.P.(P2) 3X8	5-7kgf.cm
S8	C.B.S 3X6	5-7kgf.cm
S9	C.B.S. (P2) 3X8	6-8kgf.cm
S10	C.B.S. (P4) 3X6	7-9kgf.cm
S11	C.B.S. (P4) 3X6	9-11kgf.cm
S12	C.B.S. 3X10	4-6kgf.cm
S13	C.B.S. 3X6	4-6kgf.cm
S14	C.B.S. 3X6	5-7kgf.cm
S15	C.B.S. 3X6	7-9kgf.cm
S16	C.P. 3X4	3-5kgf.cm
S17	C.P. 3X6	3-5kgf.cm
S18	C.P. 3X6	4-6kgf.cm

1.3 Removing Exterior Parts/Components

1.3.1 Printer Cover

□ Removal procedure

1. Pull out the left shaft and right shaft of the Printer Cover, and remove the Printer Cover.

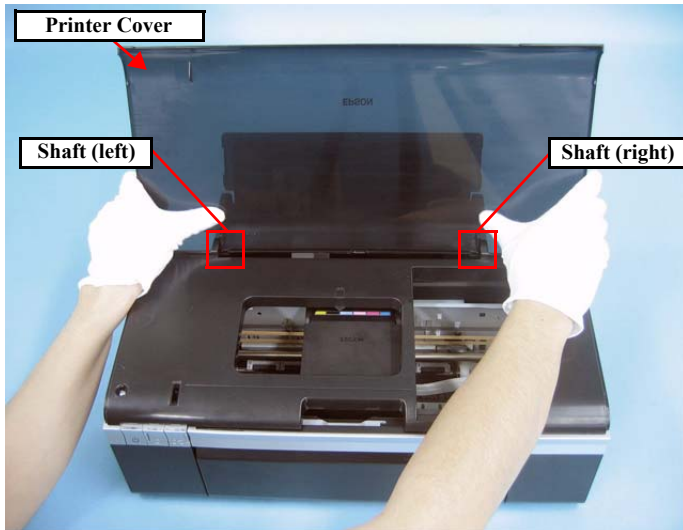

Figure 1-15. Removing the Printer Cover

1.3.2 Paper Support Assy

□ Removal procedure

1. Open the Paper Support Assy.
2. Disengage the right shaft of the Paper Support Assy from the bushing of the ASF Unit by pushing the bushing outward. Then remove the Paper Support Assy, disengaging the left shaft preventing the Edge Guide projection from hitting against the other parts.

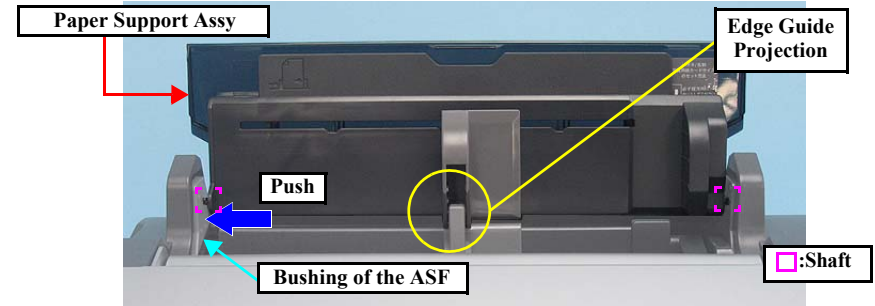

Figure 1-16. Removing the Paper Support Assy



When reinstalling the Paper Support Assy, match the projection and hole of the Edge Guide, then attach the right shaft and the left shaft in that order. (Put the shafts at the front side in the bushing and then push them rearward.) After reinstalling, check that the Paper Support Assy moves smoothly.

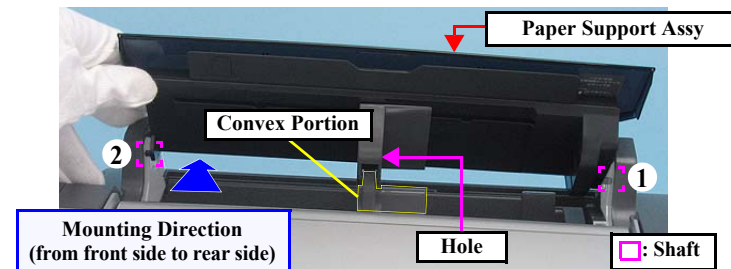

Figure 1-17. Reinstalling the Paper Support Assy

1.3.3 Stacker Assy / Stacker Cover

□ Removal procedure

1. Open the Stacker Cover.
2. Remove the Stacker Assy.
3. Release the Stacker Cover from the two shafts and remove the Stacker Cover.

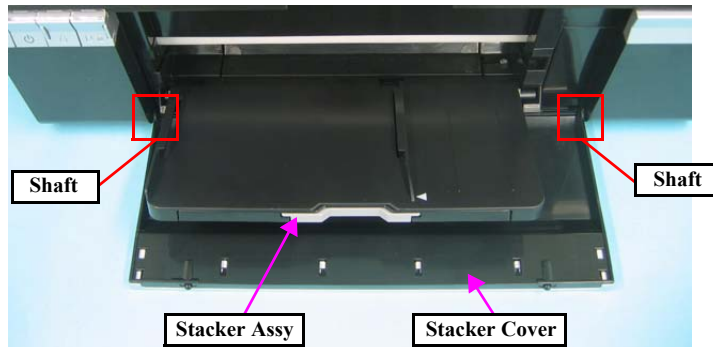

Figure 1-18. Removing the Stacker Assy / Stacker Cover



When installing the Stacker Assy, insert the guide pins of the Stacker Assy into the lower grooves of the Guide Stacker Assy. (The upper grooves are used when CDR is printed.)

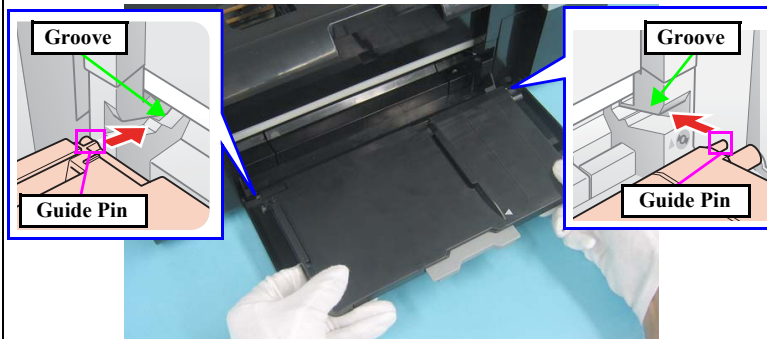

Figure 1-19. Installing the Stacker Assy

1.3.4 Housing Upper Assy

□ Removal procedure

1. Remove the four screws and remove the Upper Housing upward.
 - Screw ○: C.B.P. M3x10 (tightening torque: 5-7 kgf.cm)
 (The numbers shown in the figure indicate the order of tightening the screws.)

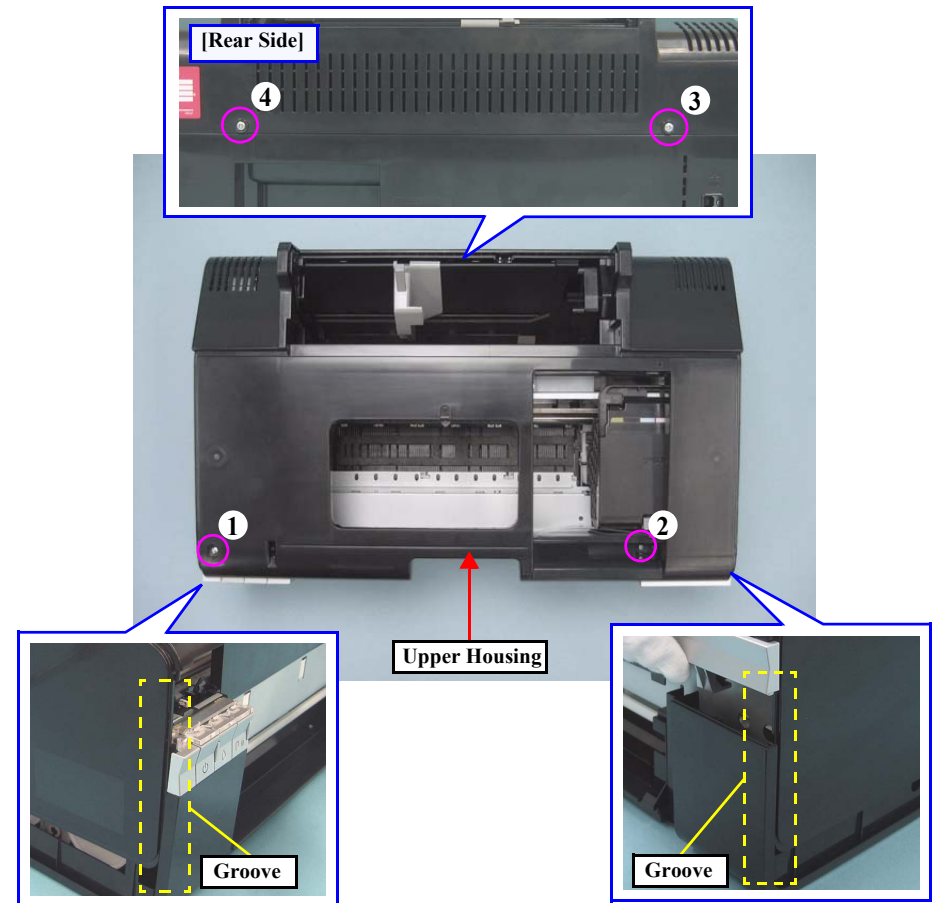

Figure 1-20. Removing the Upper Housing

2. Slide the Front Housing in the direction of the arrow and remove the Front Housing from the Upper Housing.

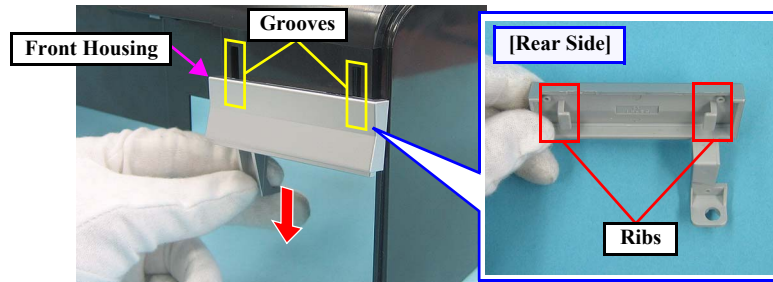

Figure 1-21. Removing the Front Housing



When installing the Upper Housing, be careful of the following:

- Do not pinch the cables.
- Tighten the screws in the order given in Fig.1-20 (p.25).
- Match the ribs of the Upper Housing shown in Fig.1-20 (p.25) with the grooves of the Housing Lower.
- As shown in Fig.1-22, match the A part of the Front Housing with the screw box of the Housing Lower.

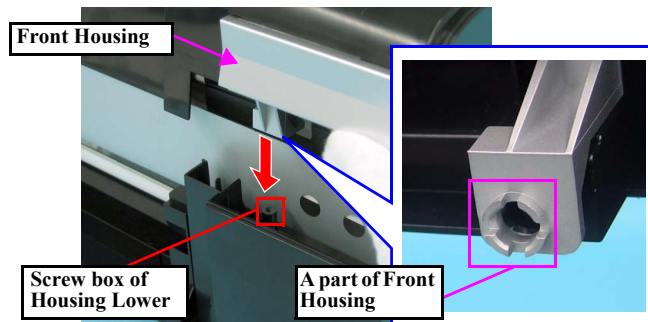

Figure 1-22. Installing Upper Housing

1.4 Removing Control Boards

1.4.1 Main Board Unit

□ Removal procedure

■ Main Board Unit removal

1. Disconnect all connectors on the Main Board Unit.
2. Peel off the double-sided tape that secures the Panel FFC to the Holder Frame and release the Panel FFC. (Fig.1-29 (p.30))

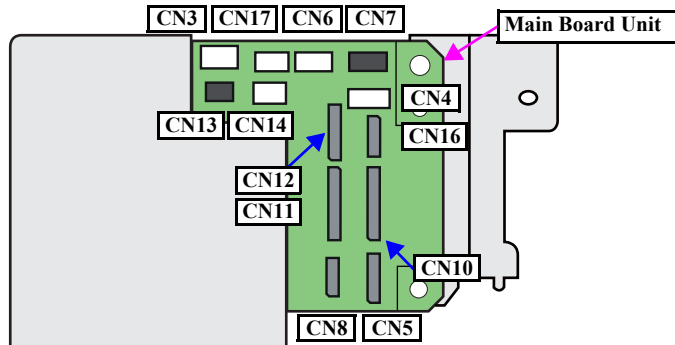

Figure 1-23. Connector layout of the Main Board

Table 1-3. List of Connectors and their Destinations

CN No.	Color	Destination	Number of pins
CN3	White	P/S Assy	3pin
CN4	White	CDR Guide Sensor / CDR Tray Sensor	4pin
CN5	FFC	Panel Board	8pin
CN6	White	PE Sensor	3pin
CN7	Black	APG Sensor	3pin
CN8	FFC	PF Encoder	5pin
CN10	FFC	Head FFC	13pin
CN11	FFC		13pin
CN12	FFC		9pin
CN13	Black	PF Motor	2pin
CN14	White	CR Motor	2pin
CN16	FFC	PW Sensor / CR Encoder Sensor	6pin
CN17	White	Cover Open Sensor	2pin

3. Peel off the four acetate tapes that secures the following cables on the back of the Main Board Unit.
 - Power Supply Cable
 - CR Motor Cable
 - PF Motor Cable
 - PE Motor Cable
 - APG Sensor Cable

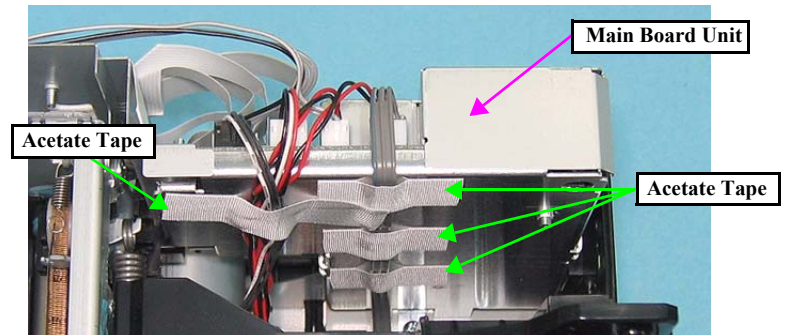



Figure 1-24. Removing the Main Board Unit (1)

4. Remove the three screws and remove the Main Board Unit.
- Screw  (2 pcs.): C.B.P.(P2) M3x8 (tightening torque: 5-7 kgf.cm)
 - Screw  (1 pc.): C.B.S. M3x6 (tightening torque: 7-9 kgf.cm)
- (The numbers shown in the figure indicate the order of tightening the screws.)

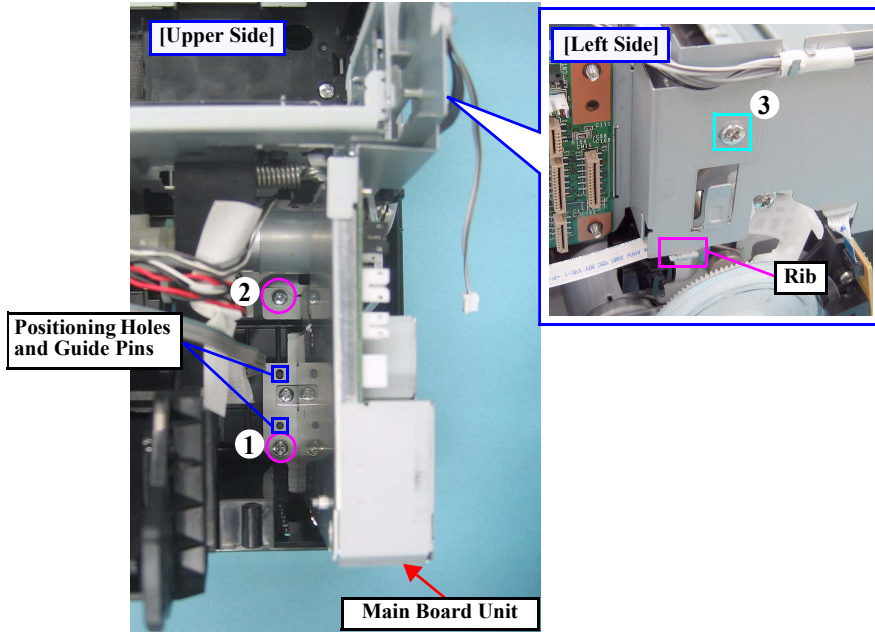

Figure 1-25. Removing the Main Board Unit (2)

ADJUSTMENT
REQUIRED



Whenever the Main Board Unit is replaced, the required adjustment must be carried out.

- Refer to "2.1.2 Required Adjustments" (p.74)

REASSEMBLY



When installing the Main Board Unit, be careful of the following:

- Match the positioning holes with guide pins shown in Fig.1-25.
- Insert the rib of the Main Board Unit into the positioning hole of the Cable Holder Frame as shown in Fig.1-25.
- Tighten the screws in the order given in Fig.1-25.

REASSEMBLY



After connecting the cables, secure them with acetate tape following the procedures below.

1. Route the Power Supply Cable closely along the Lower Shield Plate M/B, and secure the cable with acetate tapes at the positions A, B, and C (30 mm each) as shown in Fig.1-26.
2. Avoiding the sharp edge shown in Fig.1-26, secure the following cables with the acetate tape D (50 mm).
 - Power Supply Cable
 - CR Motor Cable
 - PF Motor Cable
 - PE Motor Cable
 - APG Sensor Cable

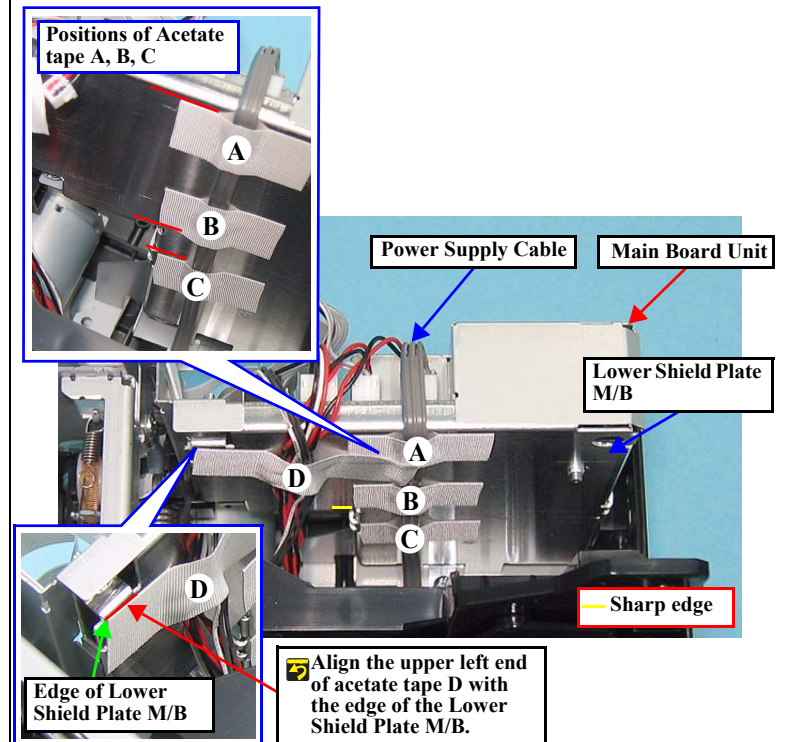



Figure 1-26. Routing the Cables

- Disassembling the Main Board Unit
- 1. Remove the Main Board Unit (p.27).



- Do not apply unnecessary force on the screw receiving parts of the Lower Shield Plate M/B, as they are easy to deform.
- When assembling or disassembling the Upper Shield Plate M/B, be careful of its sharp edges.

2. Remove the seven screws and remove the Upper Shield Plate M/B.
 - Screw  (6 pcs.): C.B.S. M3x6 (tightening torque: 5-7 kgf.cm)
 - Screw  (1 pc.): C.P. M3x6 (tightening torque: 4-6 kgf.cm)
 (The numbers shown in the figure indicate the order of tightening the screws.)

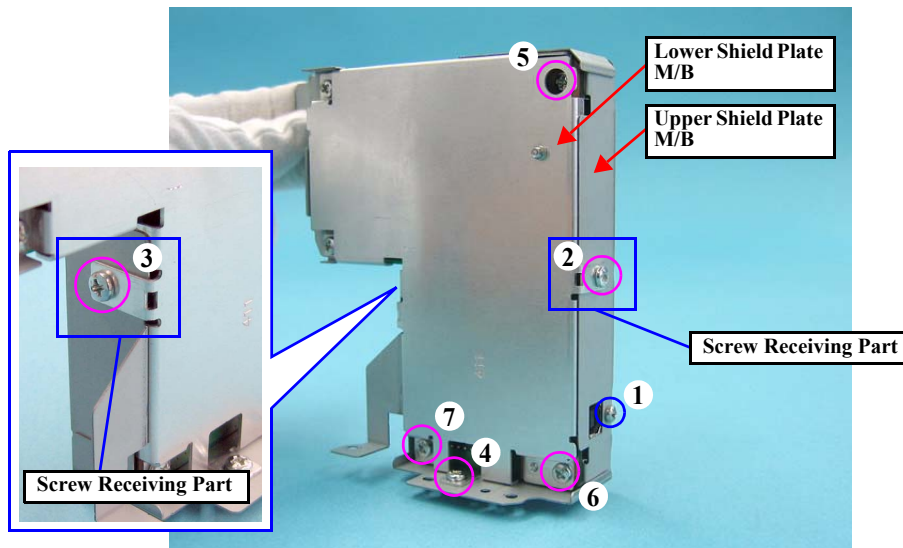



Figure 1-27. Removing the Upper Shield Plate M/B



Be careful of the sharp edges shown in the figure below when assembling or reassembling.

3. Remove the two screws and remove the Shield Plate M/B Sub.
 - Screw  (2 pcs.): C.B.S. M3x6 (tightening torque: 4-6 kgf.cm)
(The numbers shown in the figure indicate the order of tightening the screws.)
4. Remove the screw and remove the Main Board Unit.
 - Screw  C.B.S. M3x10 (tightening torque: 4-6 kgf.cm)

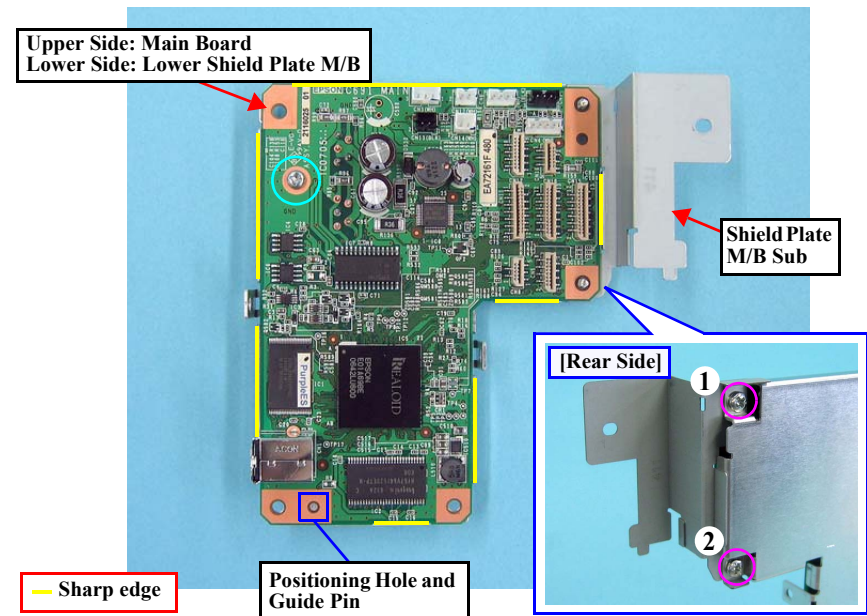

Figure 1-28. Removing the Main Board



- When installing the Main Board, match the positioning hole with the guide pin shown in Fig.1-28.
- Tighten the screws in the order given in Fig.1-27 (p.29), Fig.1-28.

1.4.2 Panel Assy/ Cover Open Sensor

□ Removal procedure

■ Panel Assy removal

1. Disconnect the Panel FFC from the connector (CN5) on the Main Board and peel the Panel FFC off the Cable Holder Frame.
2. Disconnect the CDR Sensor Cable and Cover Open Sensor Cable from the connectors (CN4, CN17) on the Main Board.
3. Release the CDR Sensor Cable and Cover Open Sensor Cable from the two hooks of the Cable Holder Frame.
4. Peel off the acetate tape A, B to separate the CDR Sensor Cable from the Cover Open Sensor Cable.

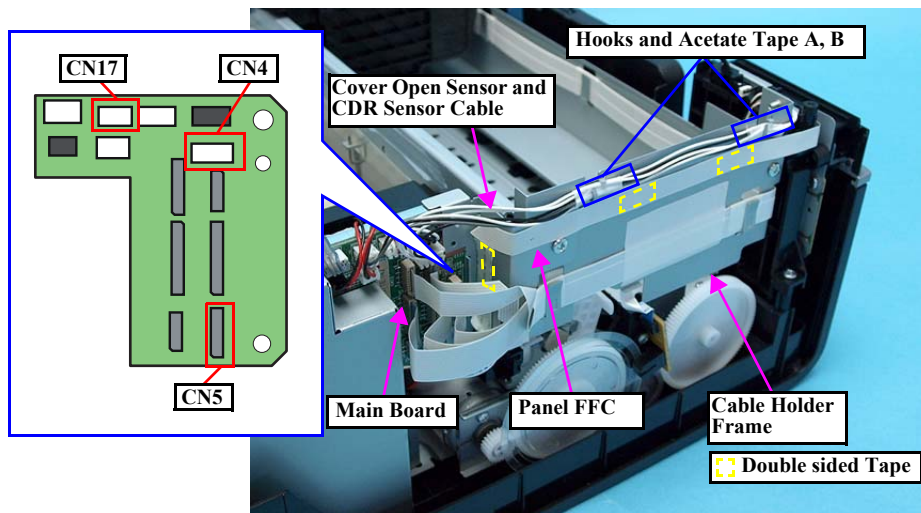



Figure 1-29. Removing the Panel Assy (1)



When removing the screw (2) shown in Fig.1-30, be careful not to damage the Cover Open Sensor Cable and CDR Sensor Cable.

5. Remove the two screws.
 - Screw  (3 pcs.): C.B.P. M3x6 (tightening torque: 5-7 kgf.cm)
 - Screw  (3 pcs.): C.B.P. M3x10 (tightening torque: 5-7 kgf.cm)
6. From the bottom of the Printer, insert a flathead screwdriver into the hole to disengage the tab, and remove the Panel Assy.

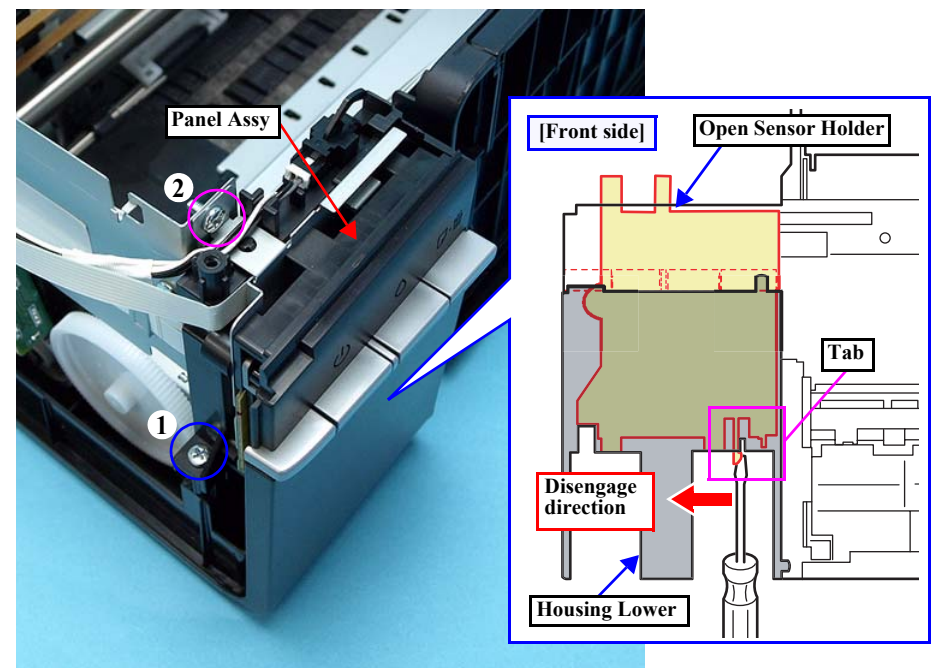

Figure 1-30. Removing the Panel Assy (2)



When Installing the Panel Assy, be careful of the following:

- Tighten the screws in the order given in Fig.1-30.
- When routing the FFCs and cables, follow the procedures below referring to Fig.1-31.
 1. Route the Panel FFC aligning its upper edge with the reference line marked on the Cable Holder Frame, and secure the FFC with double-sided tape.
 2. Attach the acetate tape C along with the edge of the Cable Holder Frame to secure the Panel FFC and Head FFC.
 3. Tie the two cables together using two pieces of acetate tape (20 mm each) so that the two tape positions come to the two hooks of the Cable Holder Frame respectively. The cables orientation must be as follows;
 - CDR cable: faces its black side upward
 - Cover Open Sensor cable: faces its gray side upward
 4. Route the cables through the two hooks of the Cable Holder Frame aligning the center of the tapes with the hooks.

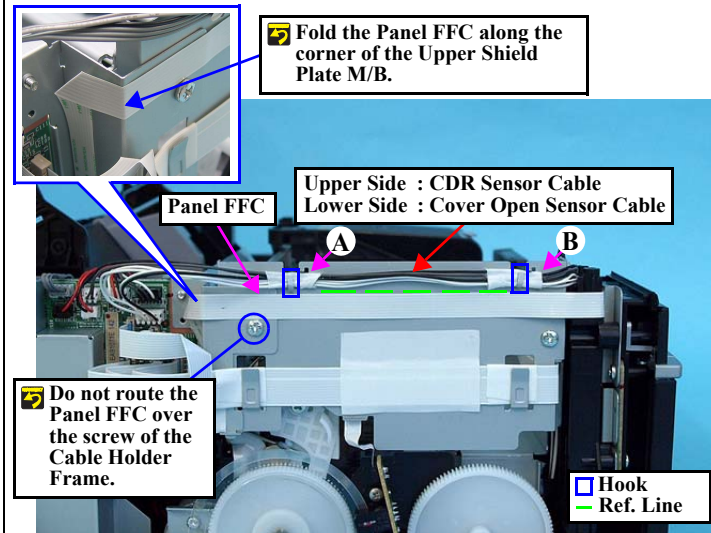

Figure 1-31. Routing the Cables



- As shown in Fig.1-32, route the CDR Sensor Cable and Cover Open Sensor Cable through the gap between the two ribs of the Open Sensor Holder.

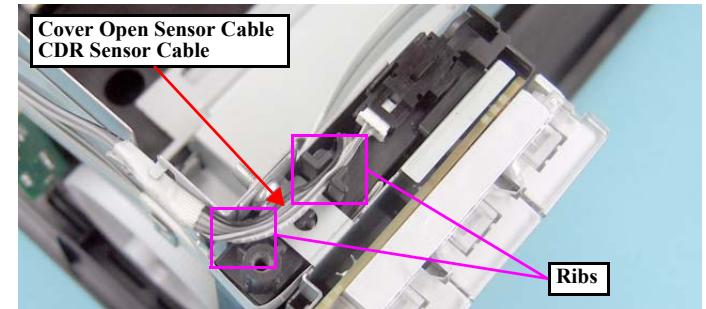

Figure 1-32. Installing the Panel Assy (1)

- As shown in Fig.1-30 (p.30) and Fig.1-33, match the positioning holes of the Open Sensor Holder with the guide pins of the Housing Lower, and secure the Open Sensor Holder with the tab.

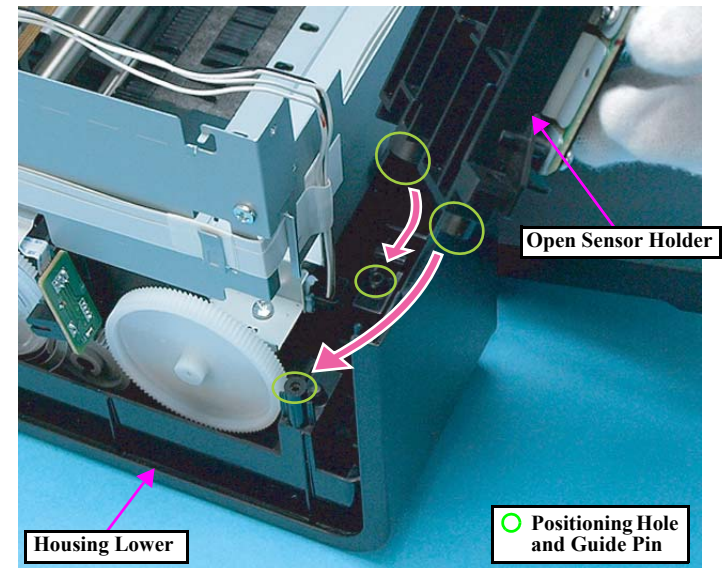



Figure 1-33. Installing the Panel Assy (2)

■ Panel Board / Buttons Removal

1. Remove the Panel Assy. (p.30)
2. Remove the two screws on the back of the Panel Assy, and remove the Panel Cover.
 - Screw  : C.B.P. M3x10 (tightening torque: 3-5 kgf.cm)
3. Remove the screw on the front of the Panel Unit, and remove the Panel Unit from the Open Sensor Holder by sliding it in the upper right direction.
 - Screw  : C.B.P. M3x10 (tightening torque: 3-5 kgf.cm)

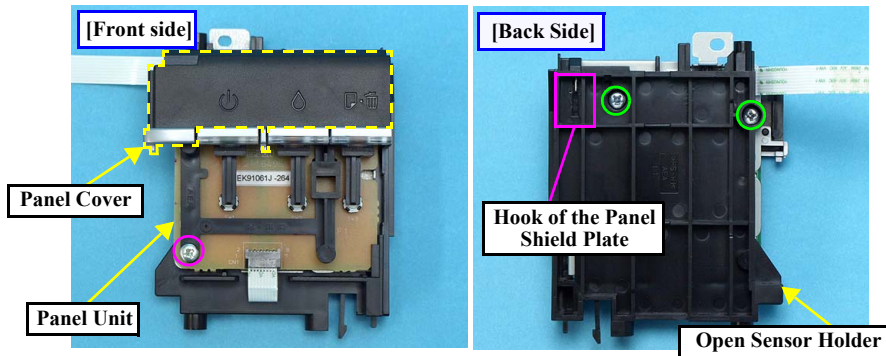



Figure 1-34. Removing the Panel Board / Buttons (1)

4. Disconnect the connector (CN1) on the Panel Board, peel the Panel FFC off the back of the Panel Shield Plate, and remove the Panel FFC.
5. Remove the two screws and remove the Panel Shield Plate from the Panel Unit.
 - Screw  : C.B.P. M3x10 (tightening torque: 3-5 kgf.cm)

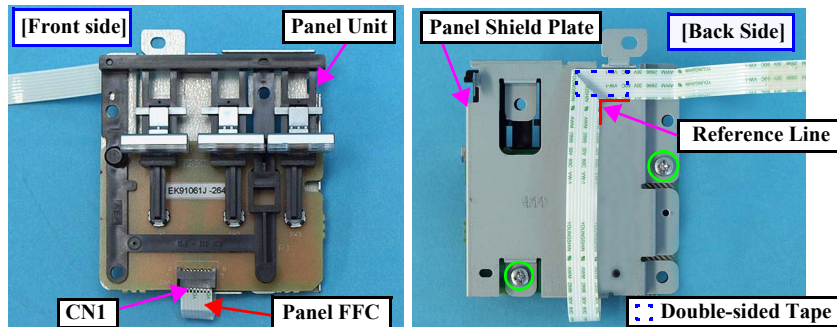

Figure 1-35. Removing the Panel Board / Buttons (2)

6. Disengage the hook on the back of the Panel Board and remove the Panel Board.

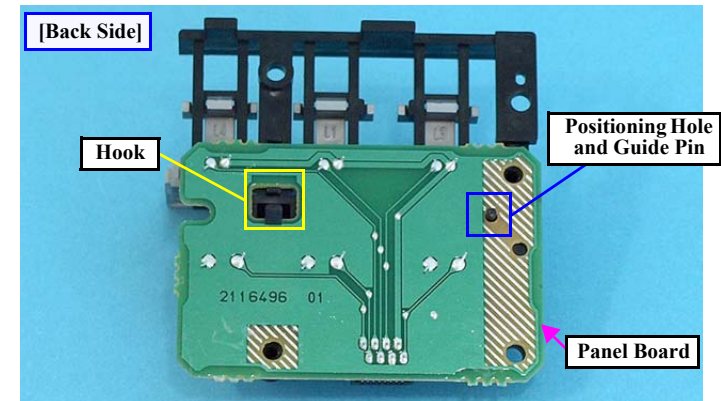

Figure 1-36. Removing the Panel Board / Buttons (3)

7. Release the three hooks and remove the PS button, the Ink button, and the Paper button from the Housing Panel B.
8. Slide the Lens of the PS button, the Ink button, and the Paper button in the direction of the arrow to remove it.

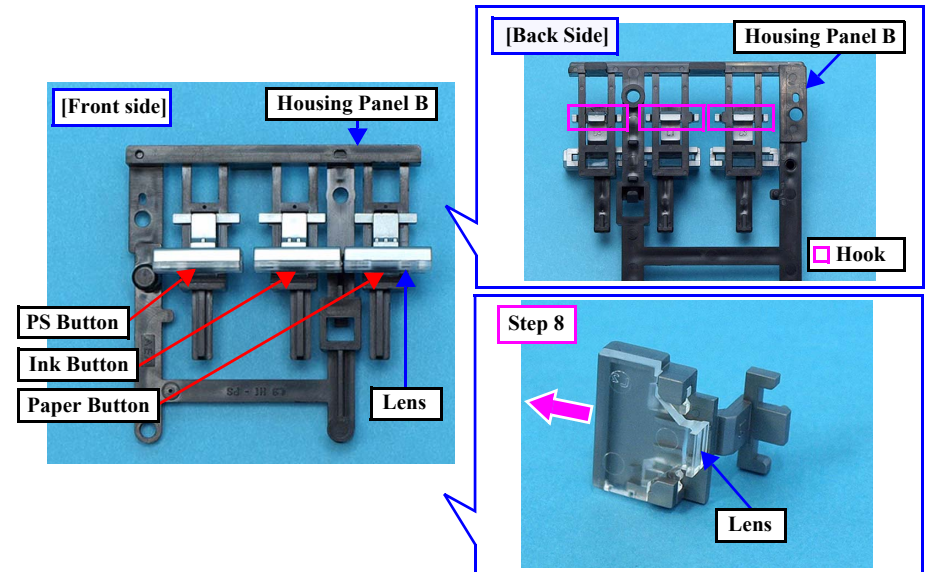

Figure 1-37. Removing the Panel Board / Buttons (4)



When installing the Panel Unit, be careful of the following:

- When installing the Panel Shield Plate to the Open Sensor Holder, match the hook and guide pins with the positioning holes shown in [Fig.1-38](#) and insert the Panel Shield Plate into the groove of the Open Sensor Holder to secure the Panel Shield Plate.

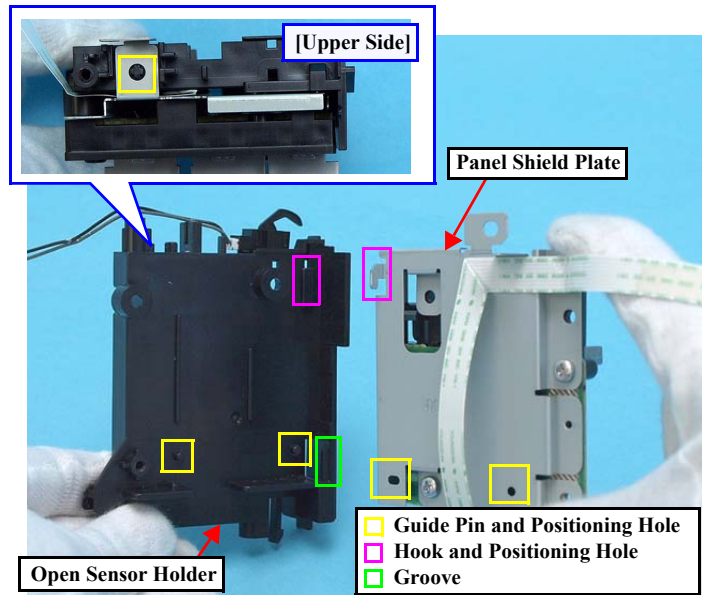

Figure 1-38. Installing the Panel Unit

- Attach the Panel FFC with double-sided tape along with the reference line shown in [Fig.1-35](#) (p.32).
- When installing the Panel Board, match the guide pin with the positioning hole shown in [Fig.1-36](#).
- Install the PS button, Ink button, and Paper button as shown in [Fig.1-37](#).

■ Cover Open Sensor Removal

1. Remove the Panel Assy. ([p.30](#))
2. From the back of the Open Sensor Holder, disengage the hook of the Cover Open Sensor, and remove the Cover Open Sensor pulling its rib out of the hole by rotating the sensor in the direction of the arrow.
3. Disconnect the connector from the Cover Open Sensor to remove the Cover Open Sensor.

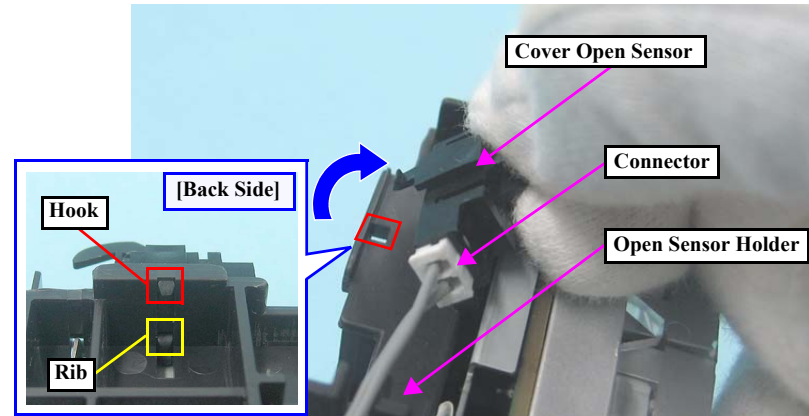



Figure 1-39. Removing the Cover Open Sensor



When installing the Cover Open Sensor, insert the rib shown in [Fig.1-39](#) into the hole of the Open Sensor Holder, and secure the Cover Open Sensor with the hook.

1.4.3 P/S Assy

□ Removal procedure

1. Peel off the acetate tape and remove the ferrite core from the groove of the Housing Lower.
 2. Remove the screw that secures the P/S Assy, and remove the P/S Assy from the Housing Lower.
- Screw  : C.B.P M3x10 (tightening torque: 5-7 kgf.cm)

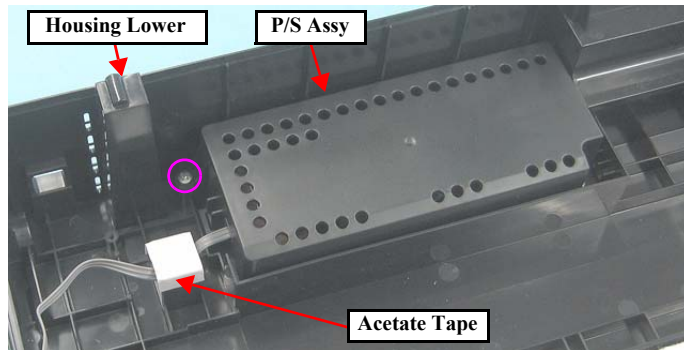

Figure 1-40. Removing the P/S Assy



When installing the P/S Assy, put the ferrite core into the groove of the Housing Lower and secure it with acetate tape as shown in Fig.1-40.



Whenever the P/S Assy is replaced, the required adjustment must be carried out.

- Refer to "2.1.2 Required Adjustments" (p.74)

1.5 Disassembling the Printer Mechanism

1.5.1 Removing the Printer Mechanism

- Removal procedure



- Be careful of the four sharp edges shown in the figure below when assembling or reassembling.
- Printer Mechanism Handling Precaution
When lifting the printer, hold  parts shown in the figure below to prevent the frame from deforming.

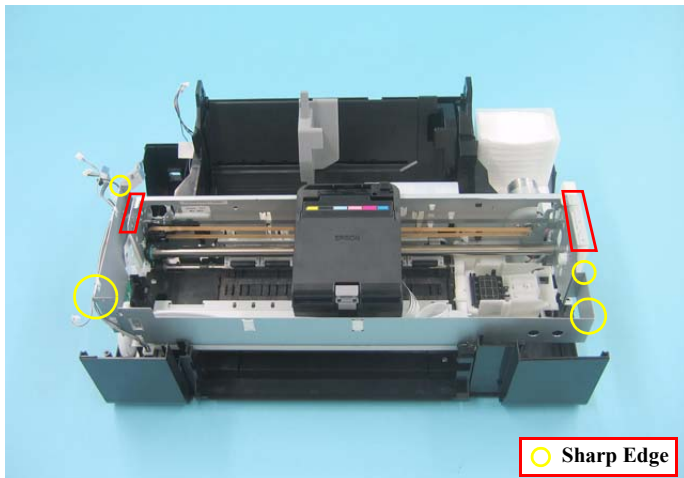

Figure 1-41. Printer Mechanism Handling Precaution (1)



- Do not touch the PF Scale with bare hands or damage it.
- If the Printer Mechanism is tilted leftward about 15°, the PF Scale hits against the desk surface and can break. After removing the Printer Mechanism, take extra care to protect the PF Scale.

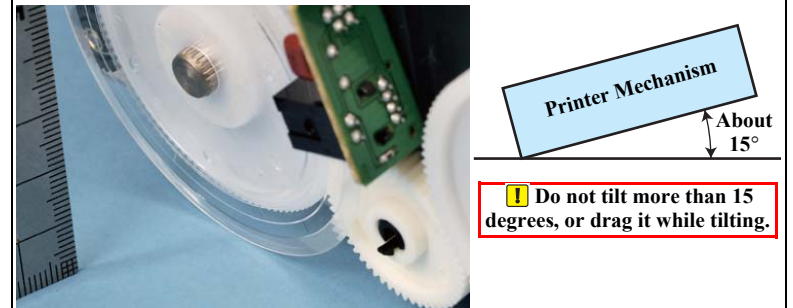

Figure 1-42. Printer Mechanism Handling Precaution (2)

- When removing the Waste Ink Tube, take care not to contaminate the printer and surroundings with ink.
- Extra care must be exercised not to scratch or damage the Waste Ink Tube.

1. Pull out the Waste Ink Tube by hand.

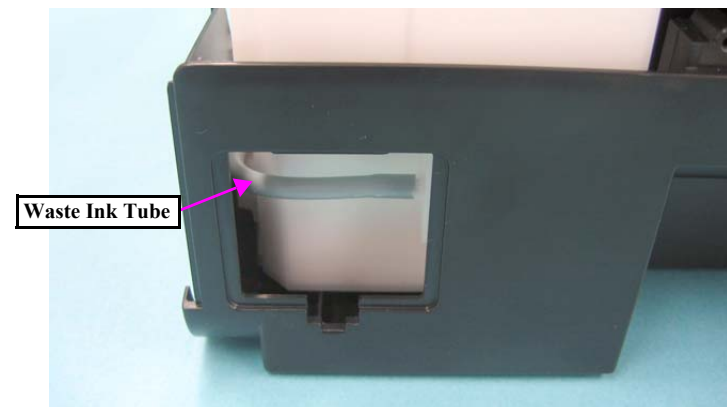



Figure 1-43. Removing the Waste Ink Tube

2. Release the Waste Ink Tube from the groove  of the Waste Ink Tray.
3. Release the CR Motor Cable from the two ribs  of the Waste Ink Tray.

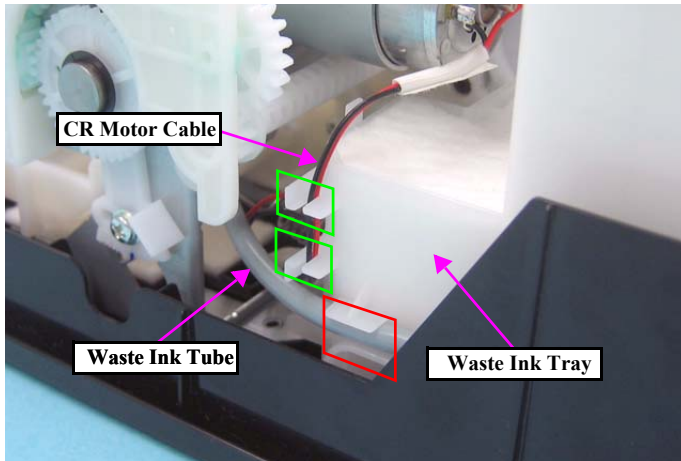

Figure 1-44. Removing the Printer Mechanism (1)

4. Disconnect the connector of the CDR Guide Sensor.

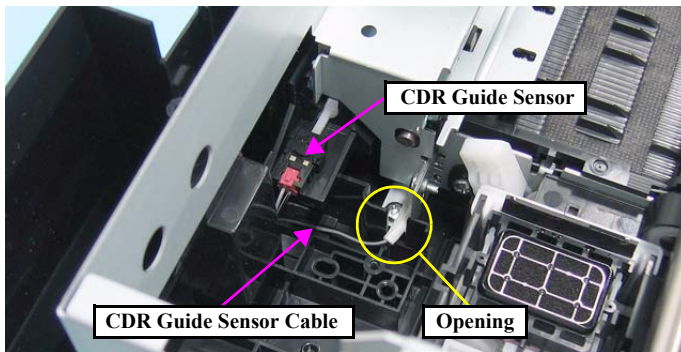



Figure 1-45. Removing the Printer Mechanism (2)

5. Remove the five screws and remove the Printer Mechanism.
Screw  : C.B.P.(P2) M3x8 (tightening torque:5-7 kgf.cm)
(The numbers shown in the figure indicate the order of tightening the screws.)

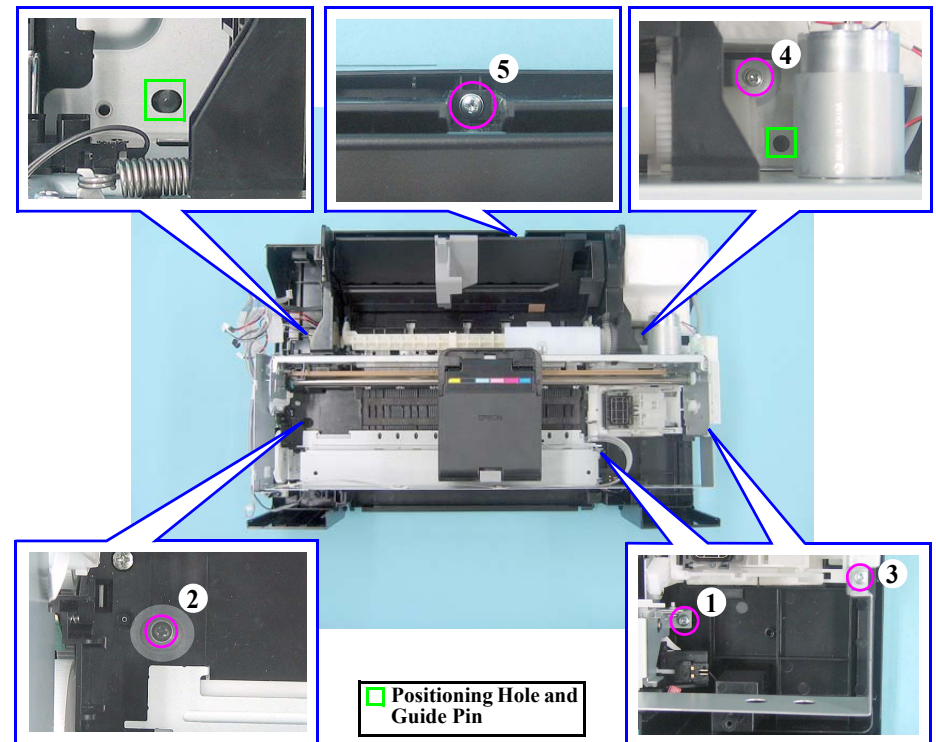

Figure 1-46. Removing the Printer Mechanism (3)



When installing the Printer Mechanism, be careful of the following:

- Wipe off any ink on the joint portion of the Waste Ink Tube before reconnecting the tube. Ink on the joint portion makes the tube likely to get disconnected.
- As shown in Fig.1-47, insert the Waste Ink Tube over the tube of the Waste Ink Tray until the top end of the Waste Ink Tube contacts with the rib.

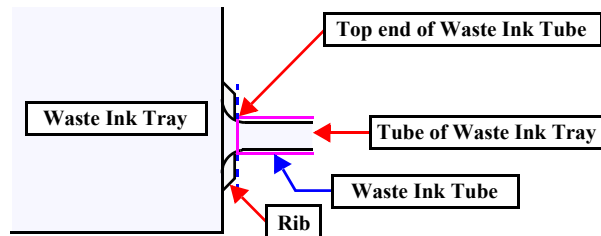

Figure 1-47. Cautions of inserting the Waste Ink Tube

- Match the positioning holes with guide pins (two pairs) shown in Fig.1-46 (p.36).
- Tighten the screws in the order given in Fig.1-46 (p.36).
- Make sure the Waste Ink Tube or cables are not pinched between the Printer Mechanism and the Housing Lower.
- Route the CDR Guide Sensor Cable through the opening as shown in Fig.1-45.



Whenever the Printer Mechanism is replaced, the required adjustments must be carried out.

- Refer to "2.1.2 Required Adjustments" (p.74)

1.5.2 Printhead



- When removing the Head FFC Cover and the Head FFC Cover Inner, do not use tools with sharp ends as the FFC may get damaged.
- Be careful not to damage the FFC and cables when disengaging the hook of the Holder Contact.

□ Removal procedure



See the section given below on how to unlock the carriage.

- "1.1.6 How to Unlock the Carriage"

1. Move the CR Unit to the center, open the Cartridge Cover and remove all Ink Cartridges.
2. While disengaging the hook of the Head FFC Cover with a flathead screwdriver, slide the Head FFC Cover downward and remove it.

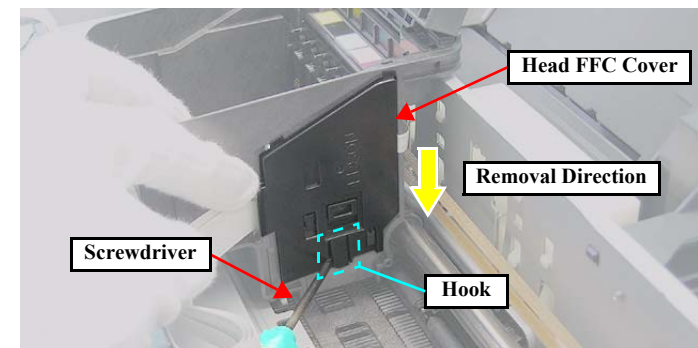

Figure 1-48. Removing the Head FFC Cover

3. While disengaging the hook of the Head FFC Cover Inner with a flathead screwdriver, slide the Head FFC Cover Inner upward and remove it.

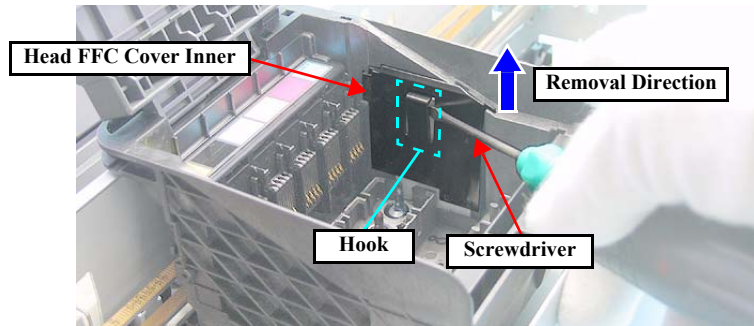

Figure 1-49. Removing the Head FFC Cover Inner

4. Using the special tool (see p. 15) disengage the hook A of the Holder Contact on the left back of the Carriage Unit.

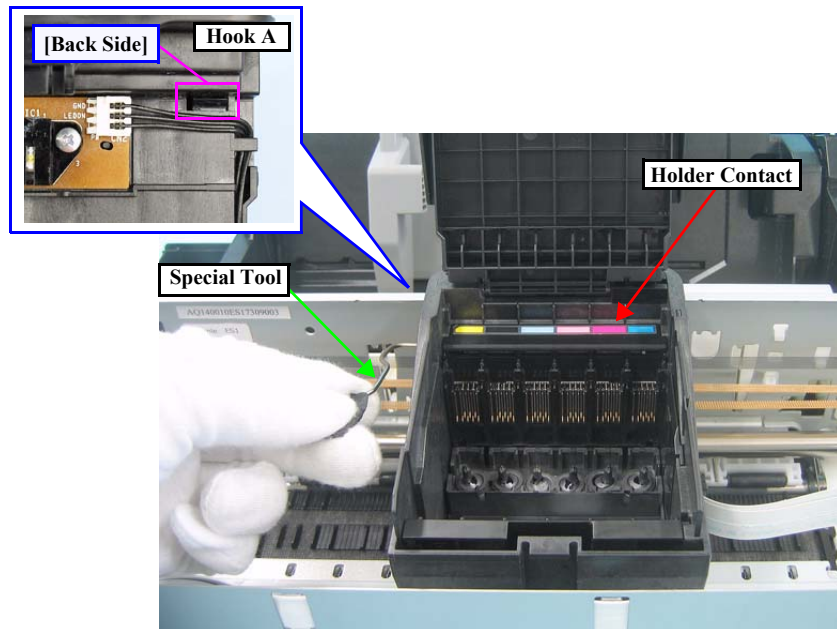

Figure 1-50. Removing the Holder Contact (1)

5. Using the special tool (see p. 15) disengage the hook B of the Holder Contact on the right back of the Carriage Unit.
6. Slide the Holder Contact upward and remove the Holder Contact.

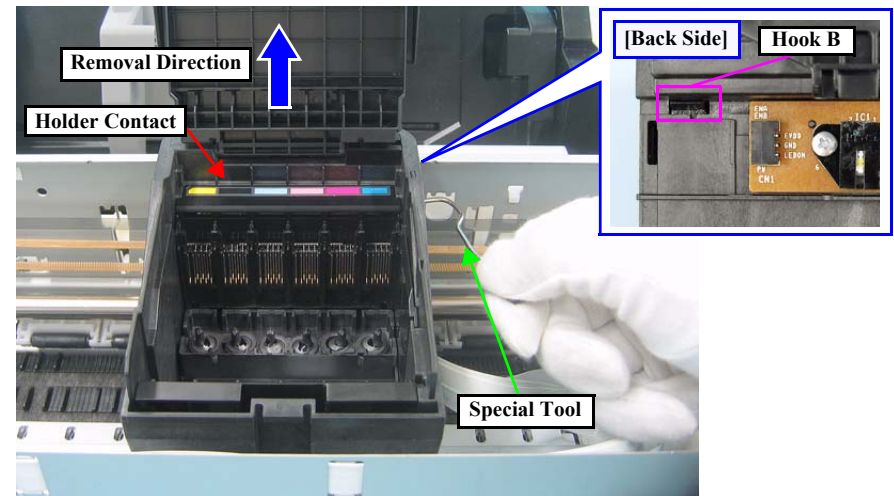

Figure 1-51. Removing the Holder Contact (2)



Take extra care not to spill ink and contaminate the surroundings. Be extremely careful not to touch the nozzle surface, the ink supply needles and the Head Cover, otherwise the nozzles may get clogged.

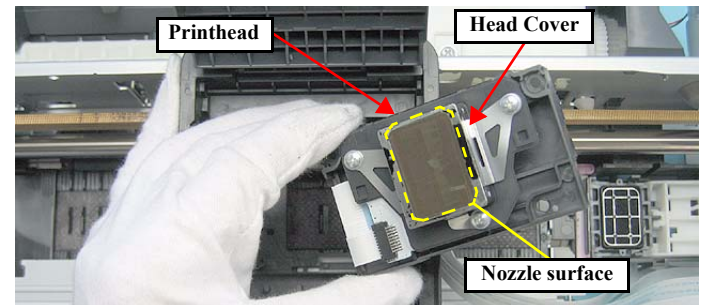



Figure 1-52. Handling of the Printhead

7. Remove the three screws and remove the Printhead.
- Screw  : C.B.P. M2.6x8 (tightening torque: 3-5 kgf.cm)
(The numbers shown in the figure indicate the order of tightening the screws.)

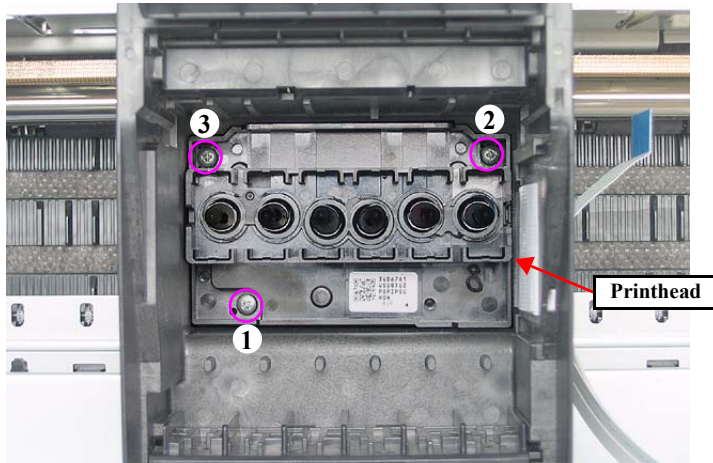

Figure 1-53. Removing the Printhead (1)

8. Remove the two Head FFCs from the connectors on the back, and remove the Printhead.

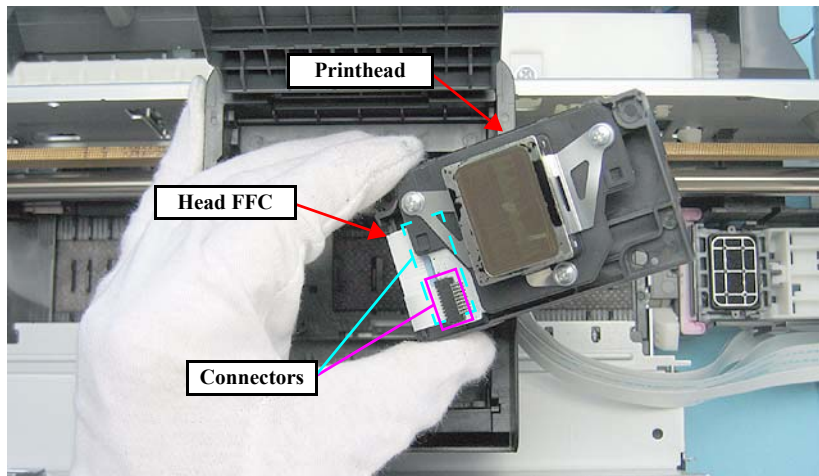

Figure 1-54. Removing the Printhead (2)



Tighten the screws in the order given in [Fig.1-53](#).



Whenever the Printhead is removed/replaced, the required adjustments must be carried out.

- Refer to "2.1.2 Required Adjustments" (p.74)

1.5.3 CR Scale



During the disassembly/reassembly of the Printer Mechanism, take extra care not to touch the CR Scale with bare hands, and not to contaminate or scratch it.

□ Removal procedure



See the section given below on how to unlock the carriage.

- “1.1.6 How to Unlock the Carriage”

1. Unlock the carriage and move the CR Unit to the center.
2. Remove the Torsion Spring from the hook (○) on the left side of the Main Frame.
3. Remove the CR Scale from the hook (□) on the right side of the Main Frame.
4. Pull out the CR Scale from the slit of the CR Unit.
5. Turn the CR Scale 90 degrees in the direction of the arrow, and remove the CR Scale from the hook.

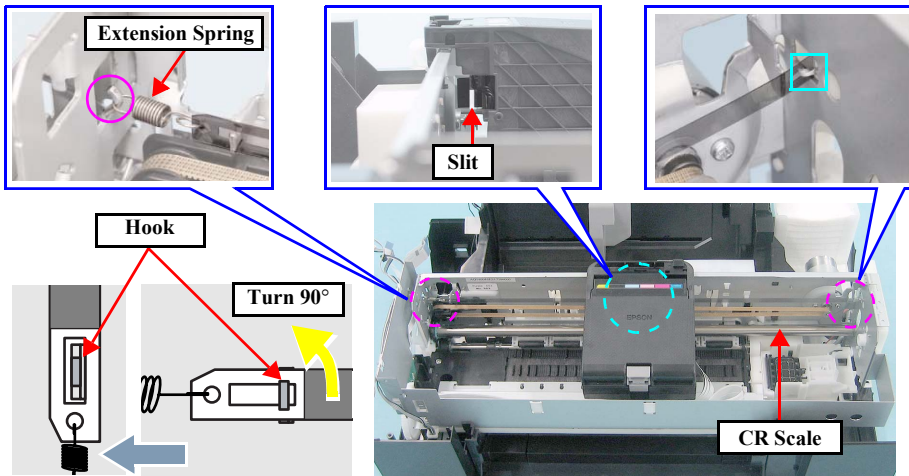

Figure 1-55. Removing the CR Scale



Install the CR Scale with its cut-corner facing upward. Hitch one end of the Torsion Spring to the hole of the CR Scale from the back side of the CR Scale.

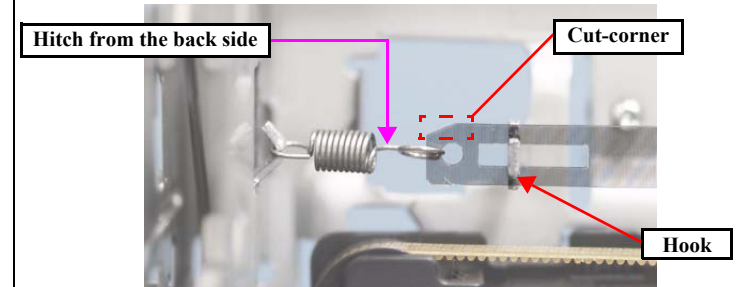



Figure 1-56. Reinstalling the CR Scale

1.5.4 APG Unit

□ Removal procedure

1. Remove the two screws taking care not to lose the gears, and remove the APG Unit.
 - Screw : C.B.S. M3x6 (tightening torque: 7-9 kgf.cm)
(The numbers shown in the figure indicate the order of tightening the screws.)

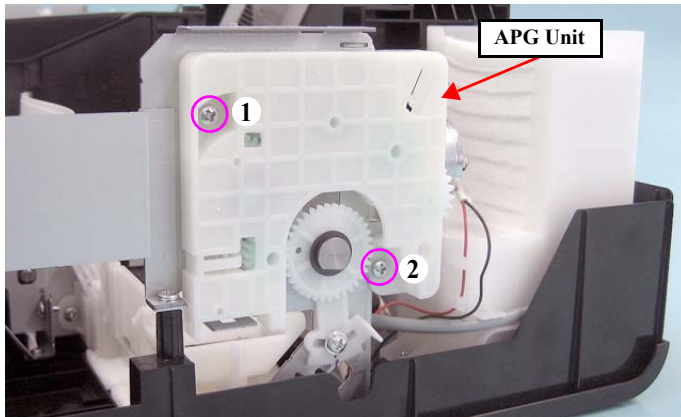

Figure 1-57. Removing the APG Unit

2. Remove the Combination Gear (10, 15.2).

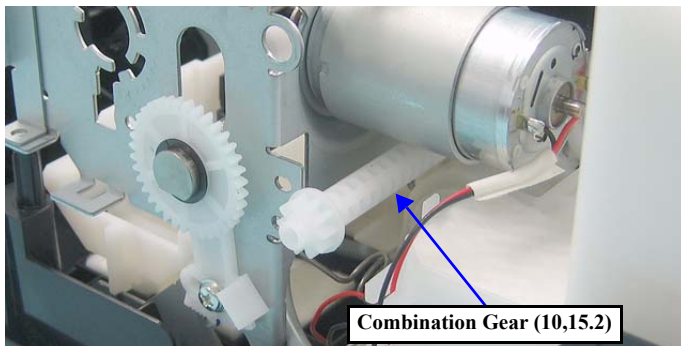

Figure 1-58. Removing the Combination Gear (10, 15.2)



- Lubrication is required. See the page given below for the lubrication information.

[Lubrication of APG Unit \(p.93\)](#)

- Install the APG Unit following the procedure below.

1. Put a pin (thinner than $\varnothing 2\text{mm}$) through the positioning holes of the Main Frame and the right PG Cam on the CR Shaft.

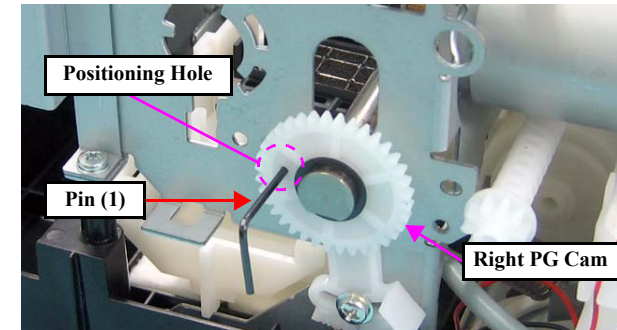

Figure 1-59. Reinstalling the APG Unit (1)

2. Put the pin through the positioning holes of the Spur gear 28.8 and the APG Unit.

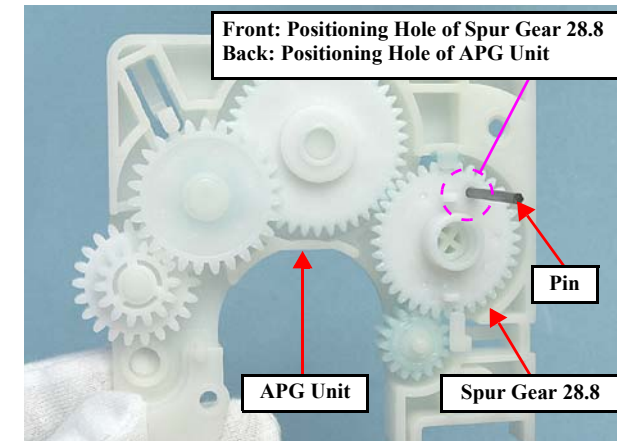

Figure 1-60. Reinstalling the APG Unit (2)

REASSEMBLY



3. Install the APG Unit to the Main Frame.

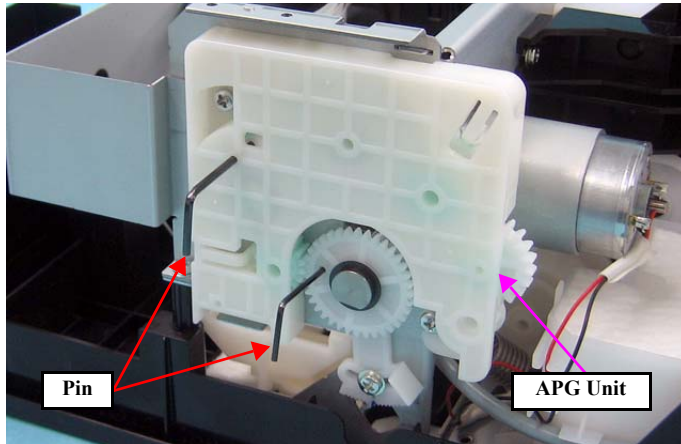

Figure 1-61. Reinstalling the APG Unit (3)

4. Check that the hooks (□) are attached to the positioning holes of the Main Frame, then screw the APG Unit.

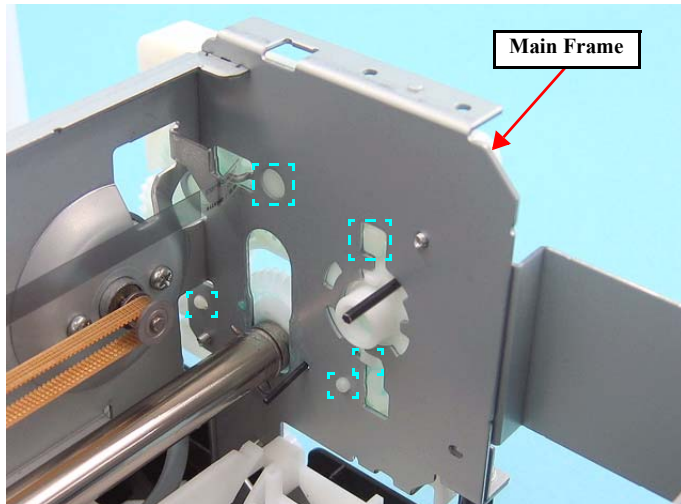

Figure 1-62. Reinstalling the APG Unit (4)

- Tighten the screws in the order given in [Fig.1-57 \(p.41\)](#).

1.5.5 Waste Ink Tray

- Removal procedure

CAUTION



When removing the Waste Ink Tray, take extra care not to spill ink and contaminate the printer and surroundings.

1. Remove the two screws, disengage the hook, and remove the Waste Ink Tray.
 - Screw ○ : C.B.P. M3x10 (tightening torque: 5-7 kgf.cm)

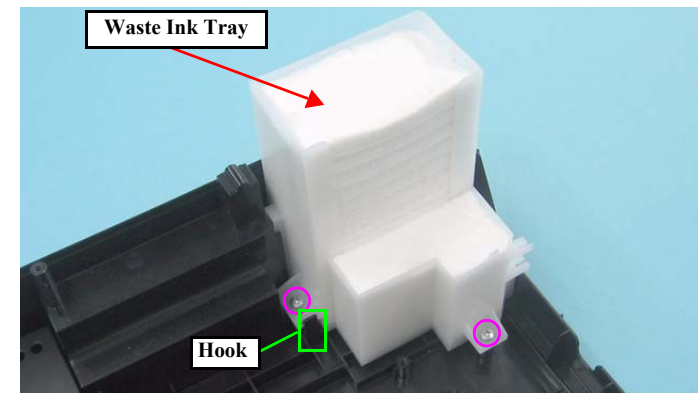

Figure 1-63. Removing the Waste Ink Tray

ADJUSTMENT
REQUIRED

Whenever the Waste Ink Tray is replaced, the required adjustments must be carried out.

- Refer to "2.1.2 Required Adjustments" (p.74)

1.5.6 Waste Ink Pad Lower / Waste Ink Pad Cap Lower

□ Removal procedure



- When removing the Waste Ink Pad Lower and Waste Ink Pad Cap Lower, take extra care not to contaminate the printer and surroundings with ink.
- Be careful of the seven sharp edges shown in [Fig.1-64](#) when disassembling or reassembling.

1. Remove the four Waste Ink Pad Lower and Waste Ink Pad Cap Lower from the Housing Lower.

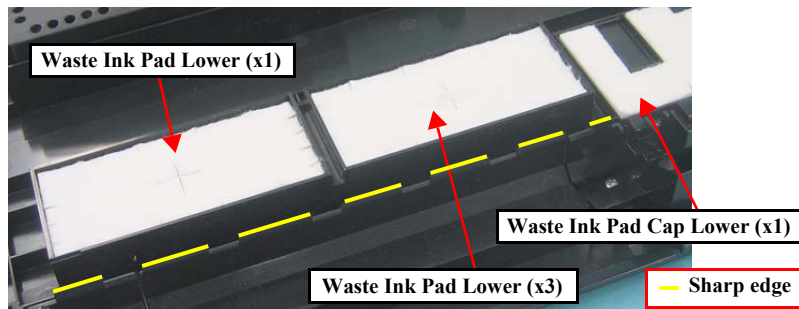



Figure 1-64. Removing the Waste Ink Pad



Insert the Waste Ink Pad Lower into the Housing Lower inserting the slits of the pads over the tabs  on the Housing Lower. Make sure to push the pads as far as they will go (until their top surface locate lower than the top surface of the Housing Lower edges).

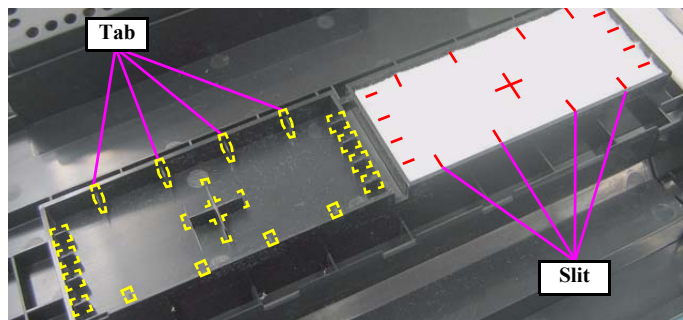

Figure 1-65. Installing the Waste Ink Pad Lower



Whenever the Waste Ink Pad Lower is replaced, the required adjustments must be carried out.

- [Refer to "2.1.2 Required Adjustments" \(p.74\)](#)

1.5.7 Left & Right Guide Stackers / CDR Guide Sensor

□ Removal procedure



Be careful of the seven sharp edges shown in Fig.1-66 when assembling or reassembling.

■ Left / Right Guide Stacker Removal

1. Remove the screw and remove the Left Guide Stacker.
 - Screw ○: C.B.P. M3x8 (tightening torque: 5-7 kgf.cm)
2. Remove the screw and remove the Right Guide Stacker.
 - Screw ○: C.B.P. M3x8 (tightening torque: 5-7 kgf.cm)

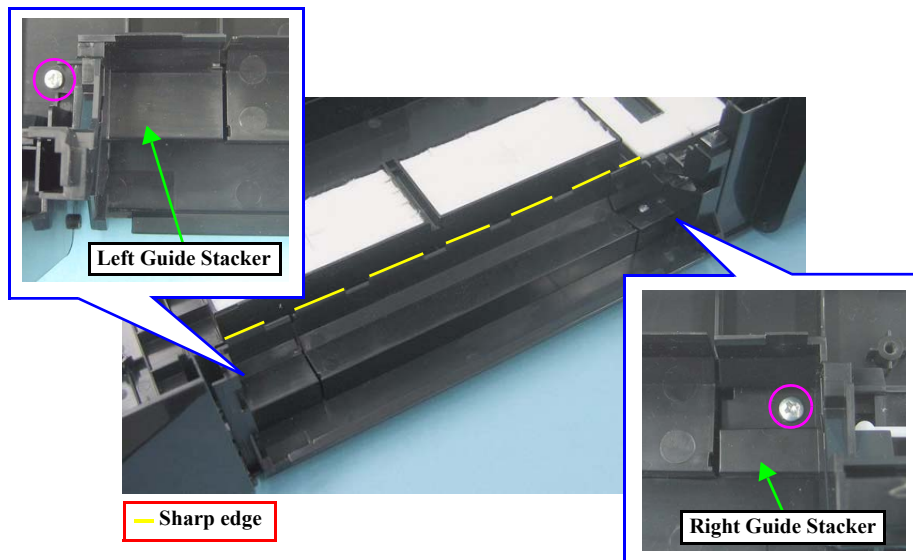

Figure 1-66. Removing the Left / Right Guide Stacker



- When installing the Left Guide Stacker, insert the rib indicated with □ in Fig.1-67 and match the positioning holes and guide pins indicated with ○ (two pairs).
- When installing the Right Guide Stacker, match the positioning holes and guide pins indicated with ○ (two pairs) in Fig.1-67.

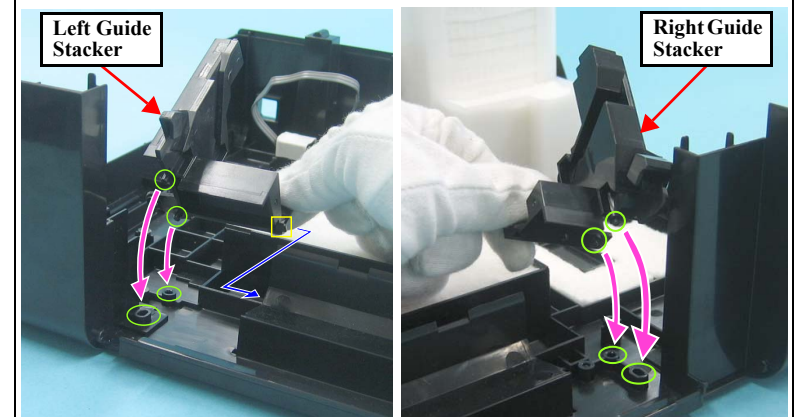

Figure 1-67. Installing the Left / Right Guide Stacker

■ CDR Guide Sensor Removal

1. Disengage the two hooks on the back of the CDR Guide Sensor and remove the CDR Guide Sensor.

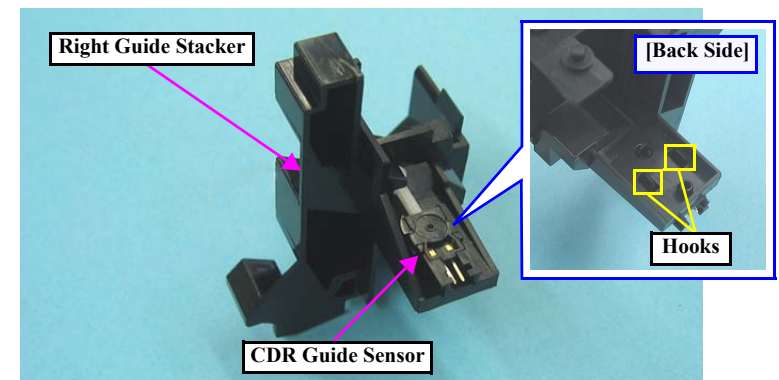

Figure 1-68. Removing the CDR Guide Sensor

1.5.8 Ink System



- Take extra care not to spill ink and contaminate the surroundings. Also, when removing the Waste Ink Tube, be careful not to spill the ink.
- Extra care must be taken to avoid injury from sharp edges of the rib of the Main Frame.
- Be careful not to drop and damage the shaft of the Carriage Lock and the Torsion Spring, as they easily come off.

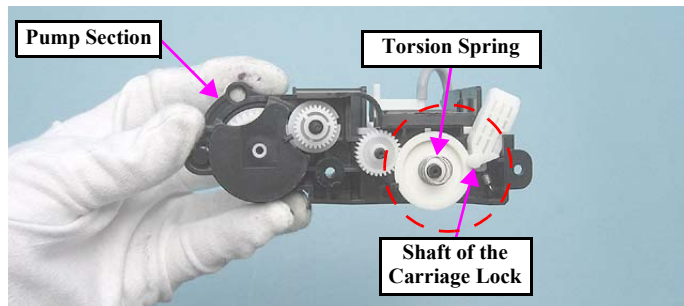

Figure 1-69. Ink System

- Removal procedure



- See the section given below on how to unlock the carriage.
- “1.1.6 How to Unlock the Carriage”

1. Move the CR Unit to the center.
2. Remove the screw (1) that secures the Cap section.
 - Screw ○: C.B.S. M3x6 (tightening torque: 7-9 kgf.cm)
(The numbers shown in the figure indicate the order of tightening the screws.)
3. Insert a screwdriver through the hole of the Main Frame and remove the screw (2) that secures the Pump section.
 - Screw ○: C.B.S. M3x6 (tightening torque: 7-9 kgf.cm)
(The numbers shown in the figure indicate the order of tightening the screws.)

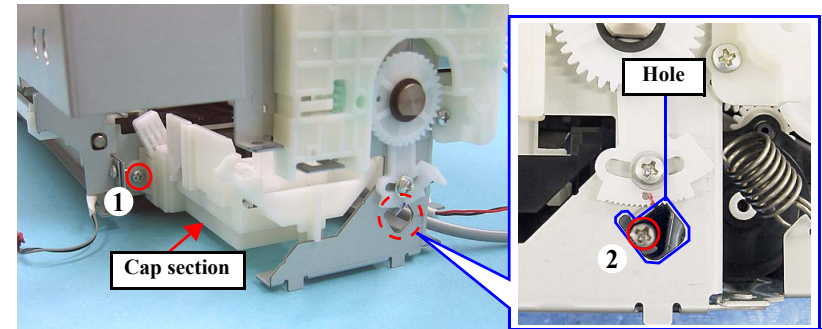

Figure 1-70. Removing the Ink System (1)

4. Slide the Ink System to the direction of the arrow and disengage the Ink System from the guide pin of the ASF Unit.

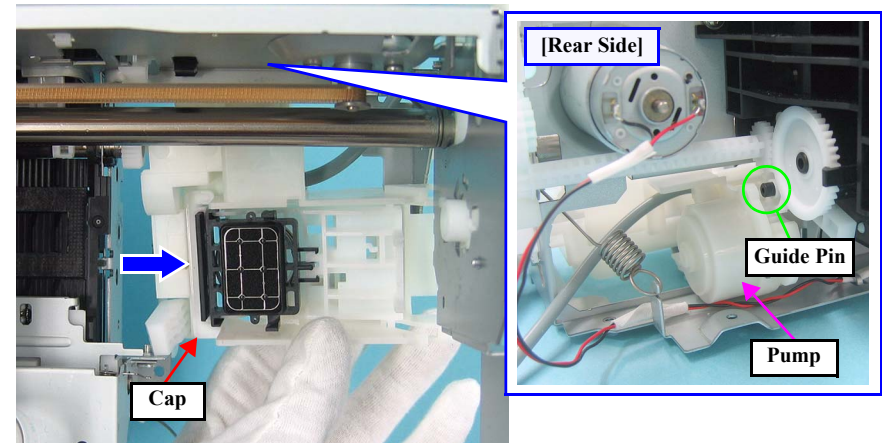

Figure 1-71. Removing the Ink System (2)

5. Remove the Ink System in the following procedures.
 1. Slide it to the right.
 2. Rotate it in the direction of the arrow (1) and release the pump part from the Main Frame.
 3. Pull it out toward you (arrow (2)).

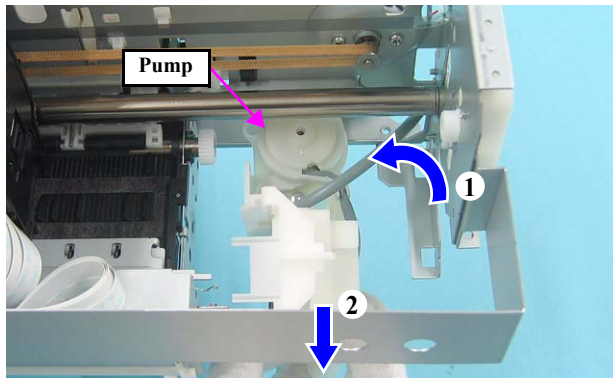

Figure 1-72. Removing the Ink System (2)



When installing the Ink System, be careful of the following:

- Lubrication is required. See the page given below for the lubrication information.
[Lubrication of Ink System \(p.93\)](#)
- Insert the shafts of the Ink System into the positioning holes (○) of the Frame.



Figure 1-73. Reinstalling the Ink System (1)

- Tighten the screws in the order given in [Fig.1-70](#).
- After installing the Ink System, check the Carriage Lock for proper operation referring to the section given below.
 - “[1.1.6 How to Unlock the Carriage](#)”
- Insert the positioning hole of the Ink System shown in [Fig.1-71](#) over the guide pin of the ASF Unit.

1.5.9 EJ Frame Assy

□ Removal procedure

1. Move the CR Unit to the home position side.
2. Remove the Tube Guide. ([p.67](#))
3. Peel off the acetate tape, and then release the Head FFC from the two hooks of the Cable Holder Frame and pull out the Head FFC through the cutout.
4. Release the Head FFC from the three hooks of the Front Frame and peel off the double-sided tape.

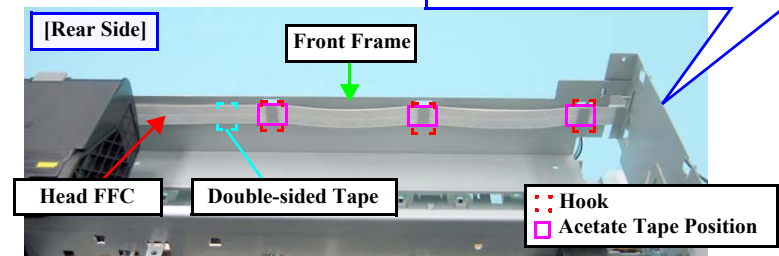
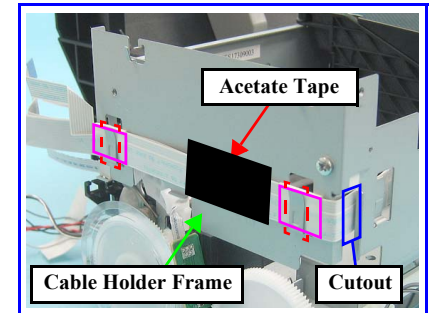



Figure 1-74. Removing the Head FFC

5. Disconnect the PF Encoder FFC from the PF Encoder.
6. Remove the two screws, disengage the two hooks of the Cable Holder Frame from the Front Frame and Main Frame, and remove the Cable Holder Frame.
7. Screw : C.B.S. M3x6 (tightening torque: 7-9 kgf.cm)
(The numbers shown in the figure indicate the order of tightening the screws.)

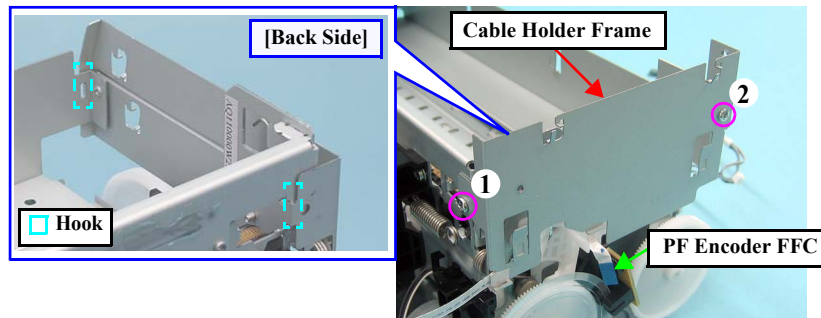

Figure 1-75. Removing the Cable Holder Frame

8. Peel off the PF Encoder FFC from the back of the Cable Holder Frame.

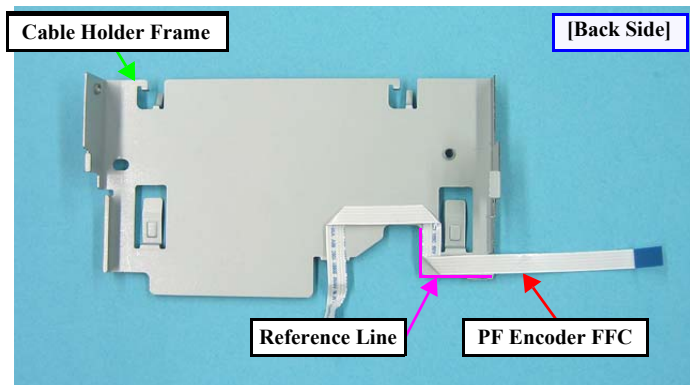



Figure 1-76. Removing the PF Encoder FFC

9. Peel off the acetate tape to release the CDR Sensor Cable, and then remove the screws on the right and left sides, and remove the Front Frame.
 - Screw : C.B.S. M3x6 (tightening torque: 7-9 kgf.cm)
(The numbers shown in the figure indicate the order of tightening the screws.)

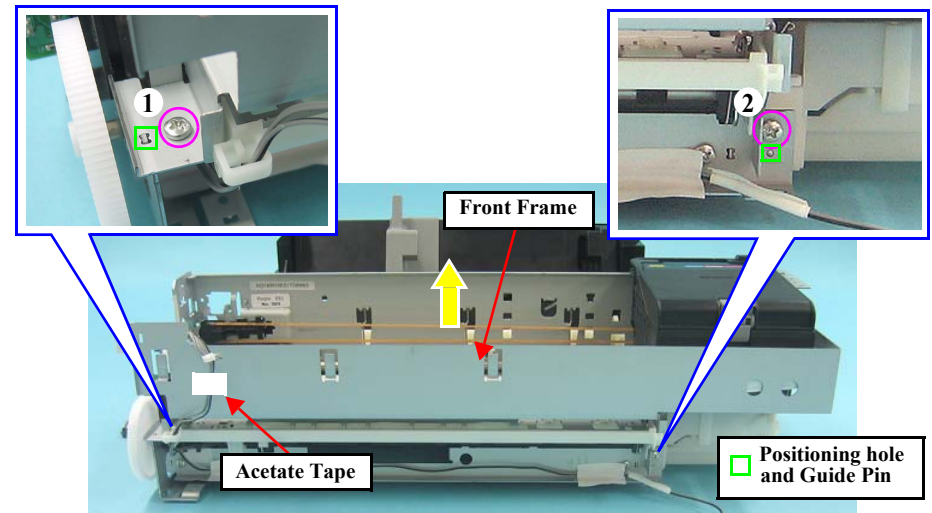

Figure 1-77. Removing the Front Frame

10. Release the CDR Sensor Cable from the cable guide of the EJ Frame Assy.
11. Remove the EJ Frame Assy.

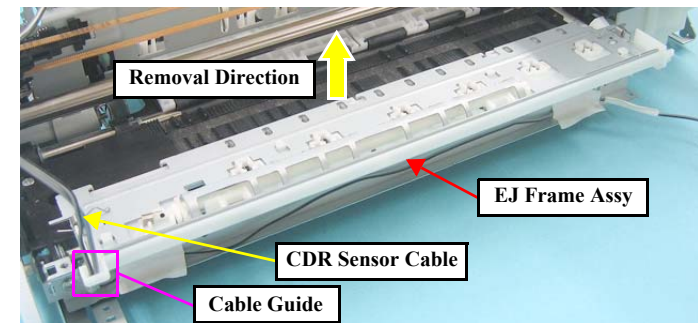

Figure 1-78. Removing the EJ Frame Assy



When installing the EJ Frame Assy, be careful of the following:

- Lubrication is required. See the page given below for the lubrication information.
[Lubrication of EJ Frame Assy \(p.91\)](#)
- As shown in [Fig.1-79](#), insert the two bearings of the EJ Frame Assy over the EJ Roller Shaft.

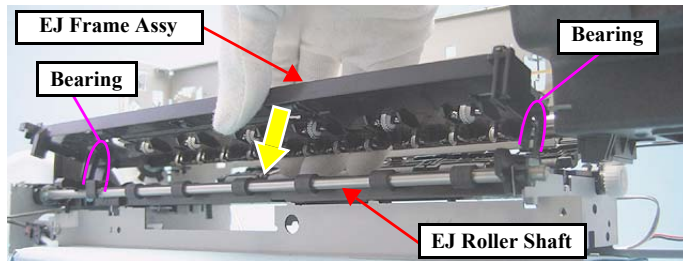

Figure 1-79. Reinstalling the EJ Frame Assy

- When installing the EJ Frame Assy, make sure that the Left/Right EJ Frame Springs are attached as shown in [Fig.1-80](#). Carefully handle the EJ Frame Assy as the springs come off easily.

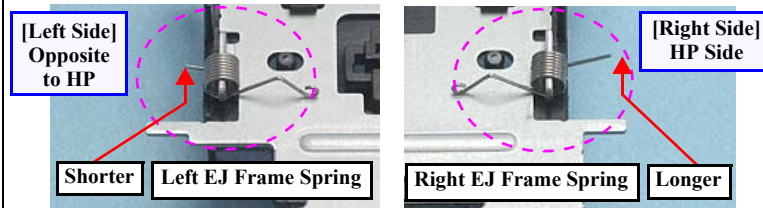

Figure 1-80. Reinstalling the Front Frame (1)



- When installing the Front Frame, screw it after securing the foot of the two EJ Frame Springs to the slits as shown in the figure. Carefully handle the EJ Frame as the springs come off easily.



Figure 1-81. Reinstalling the Front Frame (2)

- When installing the Cable Holder Frame, match the two hooks of the Cable Holder Frame with the positioning holes of the Main Frame and Front Frame as shown in [Fig.1-75 \(p.47\)](#), and tighten the screws in the order given in the figure.
- When installing the Cable Holder Frame, attach the PF Encoder FFC along with the reference line shown in [Fig.1-76 \(p.47\)](#).
- When installing the Front Frame, match the positioning holes of the Front Frame with the guide pins of the Main Frame (two pairs), and tighten the screws in the order given in [Fig.1-77 \(p.47\)](#).



Whenever the EJ Frame Assy is removed or replaced, the required adjustments must be carried out.

- [Refer to "2.1.2 Required Adjustments" \(p.74\)](#)

1.5.10 PF Encoder / PF Scale



Take extra care not to contaminate or scratch the PF Scale. Never touch the scale with bare hands.

□ Removal procedure

1. Disconnect the FFC of the PF Encoder from CN1 connector.
2. Remove the screw and remove the PF Encoder.
 - Screw  : C.B.P. M2.6x8 (tightening torque: 3.5-4.5 kgf.cm)
3. Peel off the double-sided tape attached to the center part, and remove the PF Scale.

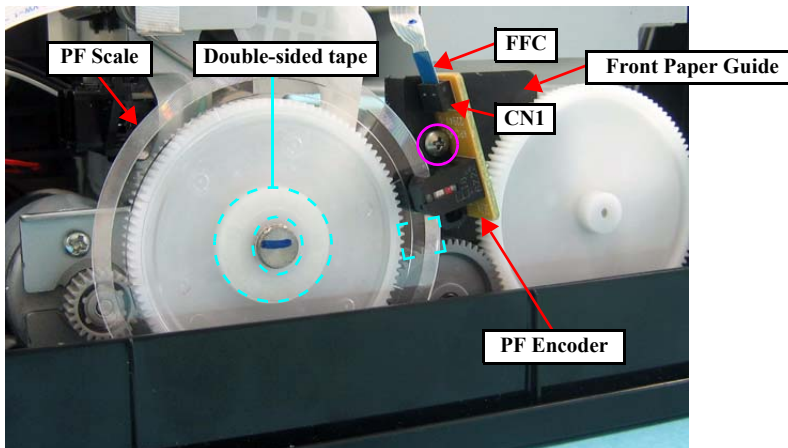

Figure 1-82. Removing the PF Encoder/PF Scale



When installing the PF Encoder, make sure the PF Encoder fits firmly against the Front Paper Guide.

1.5.11 PF Motor



Be careful not to damage the Pinion Gear of the PF Motor.

□ Removal procedure

1. Release the PF Motor Cable from the hook of the ASF Unit.
2. Remove the two screws that secure the PF Motor.
 - Screw  : C.P. M3x6 (tightening torque: 3-5 kgf.cm)
(The numbers shown in the figure indicate the order of tightening the screws.)
3. Slide the PF Motor to pull it out through the cutout and remove the PF Motor.

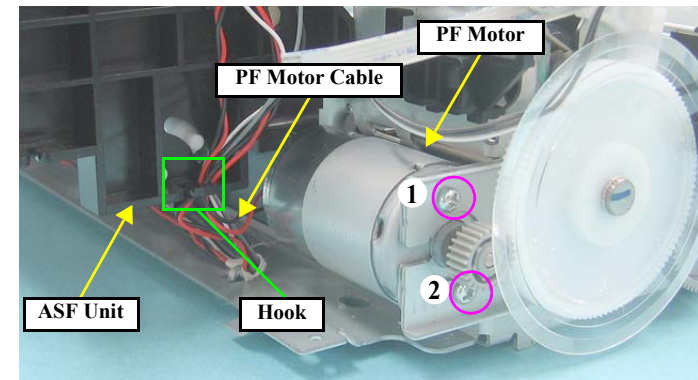

Figure 1-83. Removing the PF Motor



Whenever the PF Motor is replaced, the required adjustments must be carried out.

- Refer to "2.1.2 Required Adjustments" (p.74)

1.5.12 CR Motor

□ Removal procedure

1. Remove the Extension Spring of the Driven Pulley Assy from the rear side.

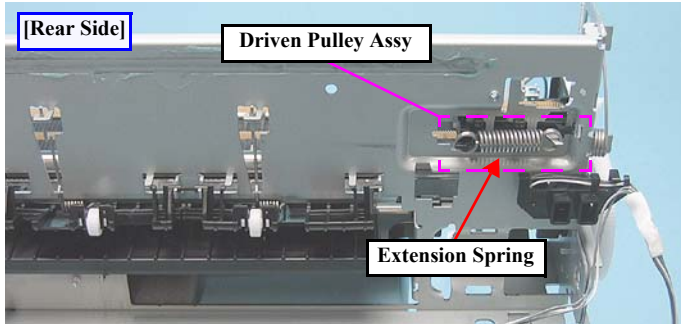

Figure 1-84. Removing the Extension Spring

CAUTION



Take extra care not to contaminate the Timing Belt with grease. The belt deteriorates faster if grease adheres to it.

2. Remove the Driven Pulley Assy and remove the Timing Belt from the Pinion Gear of the CR Motor.

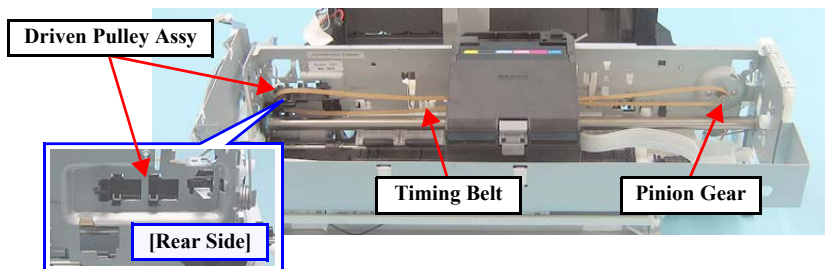

Figure 1-85. Removing the CR Motor (1)

CAUTION



When assembling or disassembling the CR Motor, be careful of the three sharp hooks of the Main Frame shown in Fig.1-86.

3. Release the connector cables from the three hooks, then peel off the three acetate tapes to release the CR Motor cable.

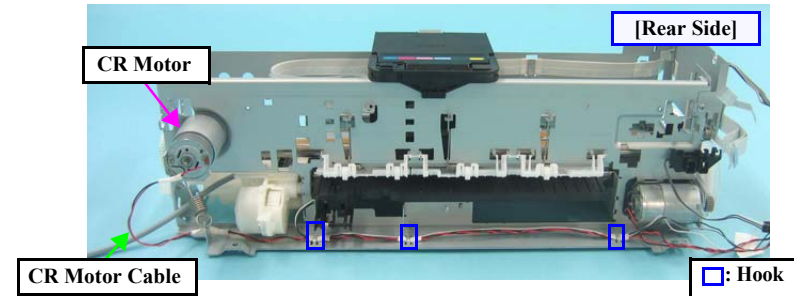

Figure 1-86. Removing the CR Motor (2)

4. Insert a Phillips screwdriver (with a shaft of 13cm or longer is recommended) through the hole of the Front Frame, remove the two screws, and remove the CR Motor.
 - Screw ○: C.P. M3x4 (tightening torque: 3-5 kgf.cm)
(The numbers shown in the figure indicate the order of tightening the screws.)

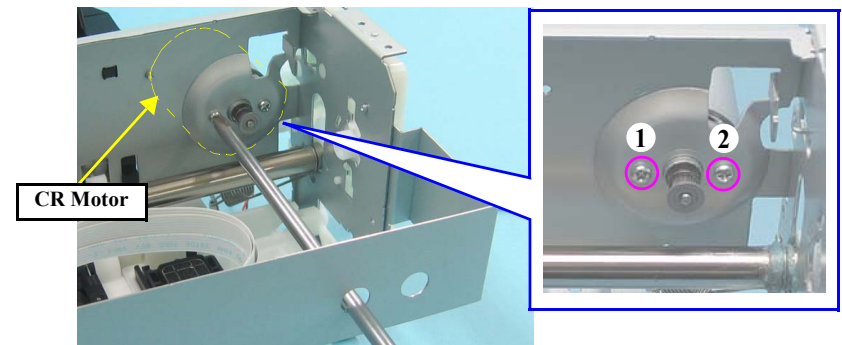

Figure 1-87. Removing the CR Motor (3)

REASSEMBLY



- When routing the CR Motor Cable and PE Sensor Cable, refer to [Fig.1-88](#) and follow the steps below.
 1. Wrap the CR Motor Cable with the acetate tape A (30 mm) at the position of 100 mm away from the acetate tape that is on the CR Motor side.
 2. Tie the two cables together with the acetate tape B (20 mm) at the position 60mm/40mm away from the acetate tape A/ PE Sensor connector.
 3. Route the center of the acetate tape A behind the convex portion of the Main Frame, and secure the tied cables with the hook (1) at the center of the acetate tape B so that the CR Motor Cable faces toward you.
 4. Wrap the CR Motor Cable and PE Sensor Cable with acetate tapes (20 mm) at the positions of the hooks (2) (3), then secure the center of the acetate tapes with Hooks (2) (3).

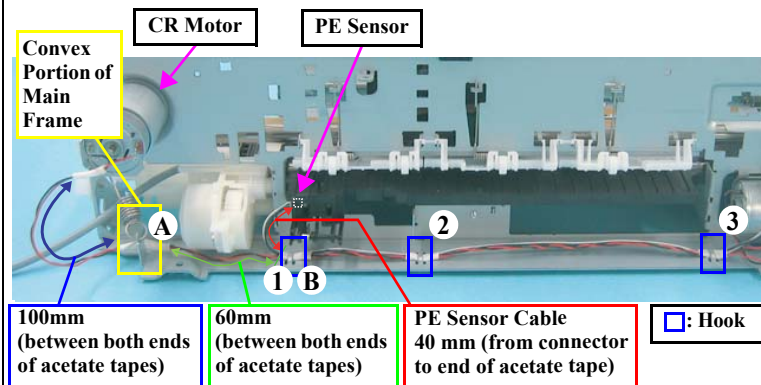

Figure 1-88. Routing the Cable

REASSEMBLY



- Lubrication is required. See the page given below for the lubrication information.
 - [Lubrication of Driven Pulley \(p.90\)](#)
- When installing the CR Motor, install it so that the print side faces upwards.



Figure 1-89. Reinstalling the CR Motor

ADJUSTMENT
REQUIRED

- Whenever the CR Motor is replaced, the required adjustments must be carried out.
 - Refer to "2.1.2 Required Adjustments" (p.74)

1.5.13 CR Unit

□ Removal procedure

CAUTION



Before turning the Parallelism Bushing L, mark the scale position of the Parallelism Bushing with a marker. And taking extra care not to damage the Gear with the rib, pull it toward the front.

1. Remove the Cable Holder Frame. (p.47)
2. Disengage the upper end of the Spring (1) from the slit, and remove the Spring (1).
3. Loosen the screw (○), and turn the Parallelism Bushing L clockwise to the maximum.

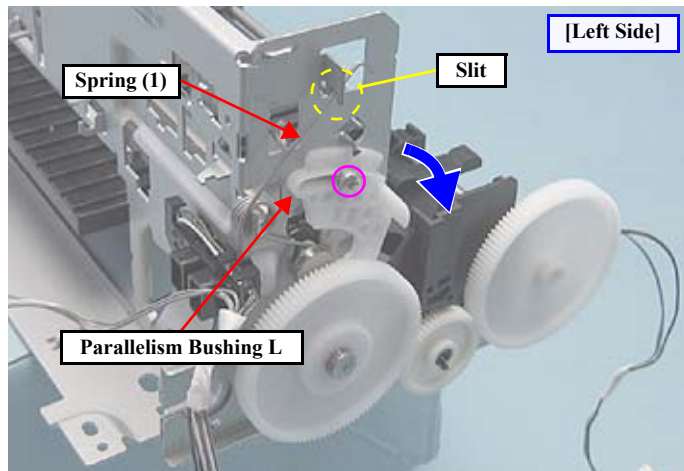

Figure 1-90. Removing the CR Unit (1)

4. Disengage the end of the Spring (2) from the hook, and the other end from the slit of the CR shaft, and remove the Spring (2).
5. Remove the washer by expanding the gap between the washer and the Right PG Cam using a pair of Tweezers, and remove the Right PG Cam.

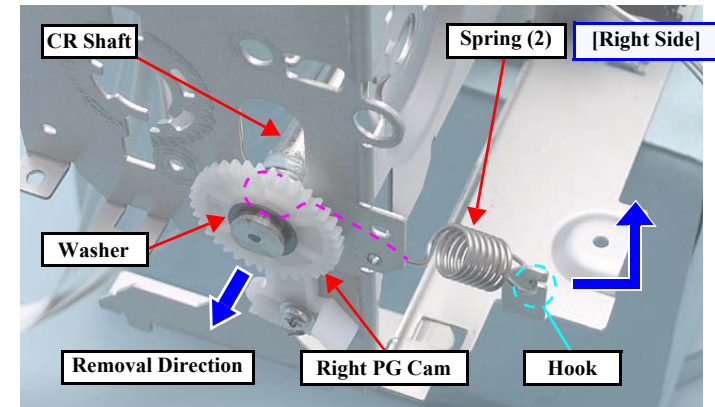

Figure 1-91. Removing the CR unit (2)

CAUTION



When removing the CR Unit in the next step, be careful not to damage the CR Shaft by bumping it against the pinion gear of the CR Motor.

6. Hold the CR Unit from the bottom and lift up the CR Shaft, release from the bushing in the (1) (2) order, and remove the CR Unit with the Shaft from the Main Frame.

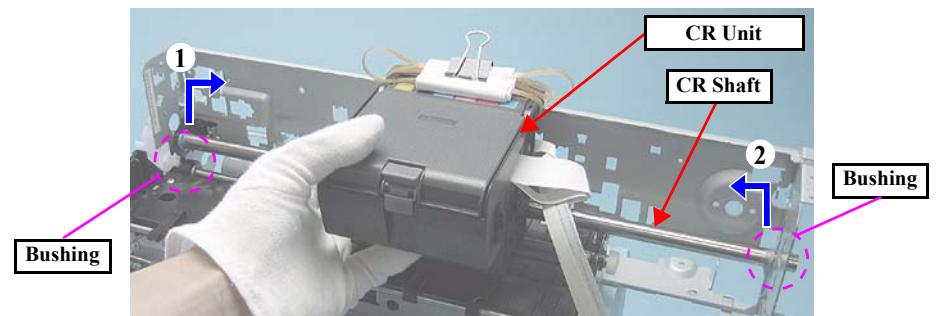

Figure 1-92. Removing the CR Unit (3)

7. Remove the CR Shaft from the CR Unit.



Figure 1-93. Removing the CR Unit (4)

8. Remove the Timing Belt from the CR Unit.

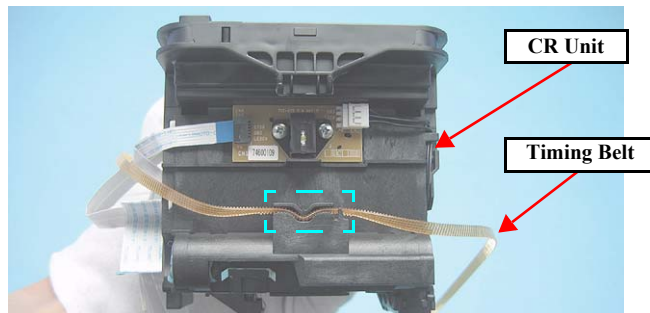

Figure 1-94. Removing the CR Unit (5)

9. Disconnect the FFC from the CR Encoder connector, pull out the FFC from the slit of the CR Unit, and remove the Head FFC.

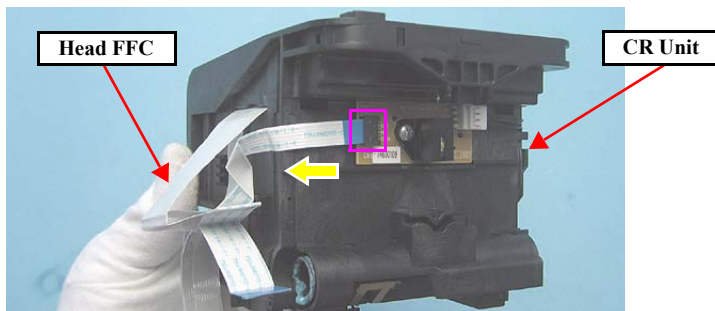

Figure 1-95. Removing the CR Unit (6)



- Lubrication is required. See the page given below for the lubrication information.
[Lubrication of CR Unit \(p.92\)](#)
- Before attaching the right PG cam, remove the APG Unit and install the cam matching its phase with the APG Unit. (Refer to Reinstalling the APG Unit (p.41))
- When attaching the spring (2) and the washer for the Right PG Cam to the CR Shaft, make sure to attach them to the positioning slits on the CR Shaft. (See [Fig.1-91 \(p.52\)](#))
- When installing the Timing Belt, make sure that it is not twisted and the lumpy side comes to the inner side.

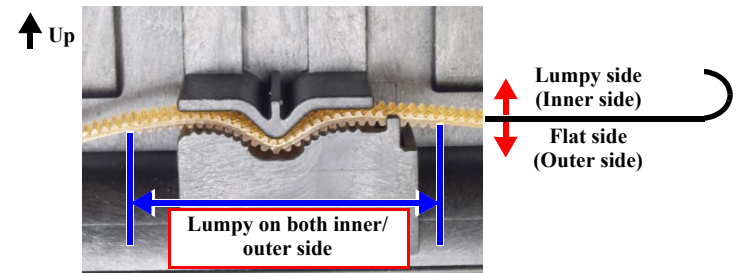

Figure 1-96. Reinstalling the Timing Belt

- When installing the CR Unit, hook the Guide part to the Main Frame.

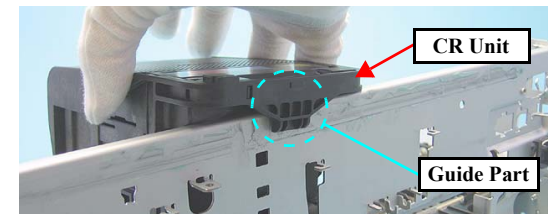

Figure 1-97. Reinstalling the CR Unit



Whenever the CR Unit is removed or replaced, the required adjustments must be carried out.

- Refer to "2.1.2 Required Adjustments" (p.74)

1.5.14 ASF Unit

□ Removal procedure

■ Removing the LD Roller Guide

1. Move the CR Unit to the left (the opposite side to the home position).
2. Remove the screw that secures the LD Roller Guide.
 - Screw  : C.B.S. (P4), M3x6 (tightening torque: 7-9 kgf.cm)



When performing the following steps, be careful not to damage the hooks of the LD Roller Guide.

3. Push the tabs on the right and the left, slide the LD Roller Guide upward to remove it disengaging the five hooks.

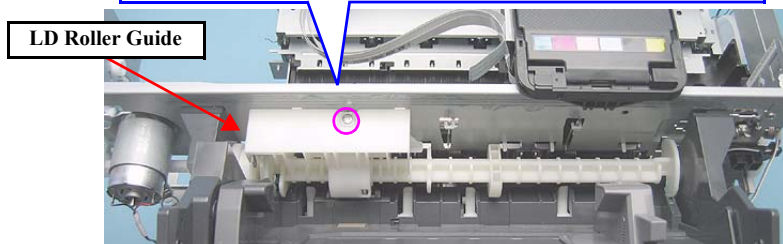
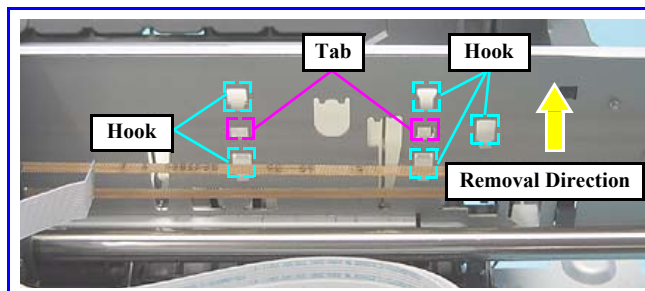

Figure 1-98. Removing the LD Roller Guide (1)

4. Remove the Torsion Spring 137.7 from the LD Roller Guide.

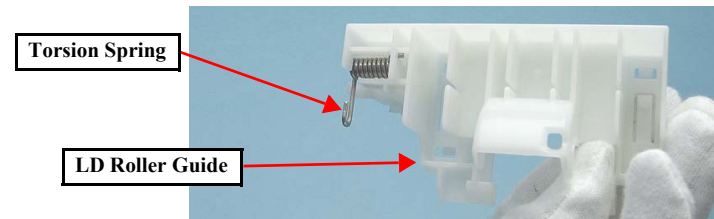

Figure 1-99. Removing the LD Roller Guide (2)

■ Removing the ASF Unit

1. Release the following cables from the ASF Unit.
 - CR Motor Cable
 - PF Motor Cable
 - PE Motor Cable

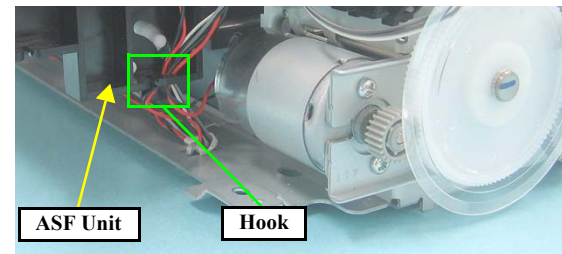



Figure 1-100. Releasing the Cables

2. Remove the two screws on the rear side.

- Screw  : C.B.S.(P4), M3x6 (tightening torque: (1) 7-9 kgf.cm, (2) 9-11 kgf.cm)
(The numbers shown in the figure indicate the order of tightening the screws.)

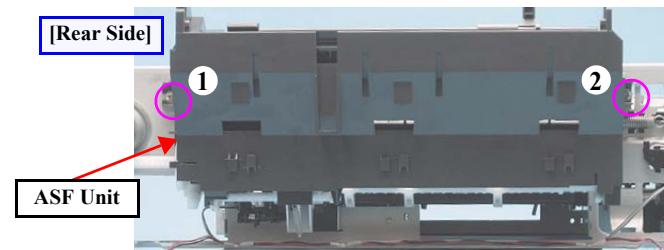

Figure 1-101. Disengaging the Hooks (ASF Unit)

3. Disengage the two hooks (1) (2) that secure the ASF Unit from the Main Frame.
4. Remove the Combination Gear (10,15.2), then remove the ASF Unit while releasing the edge of the Change Lever from the hole of the Main Frame.

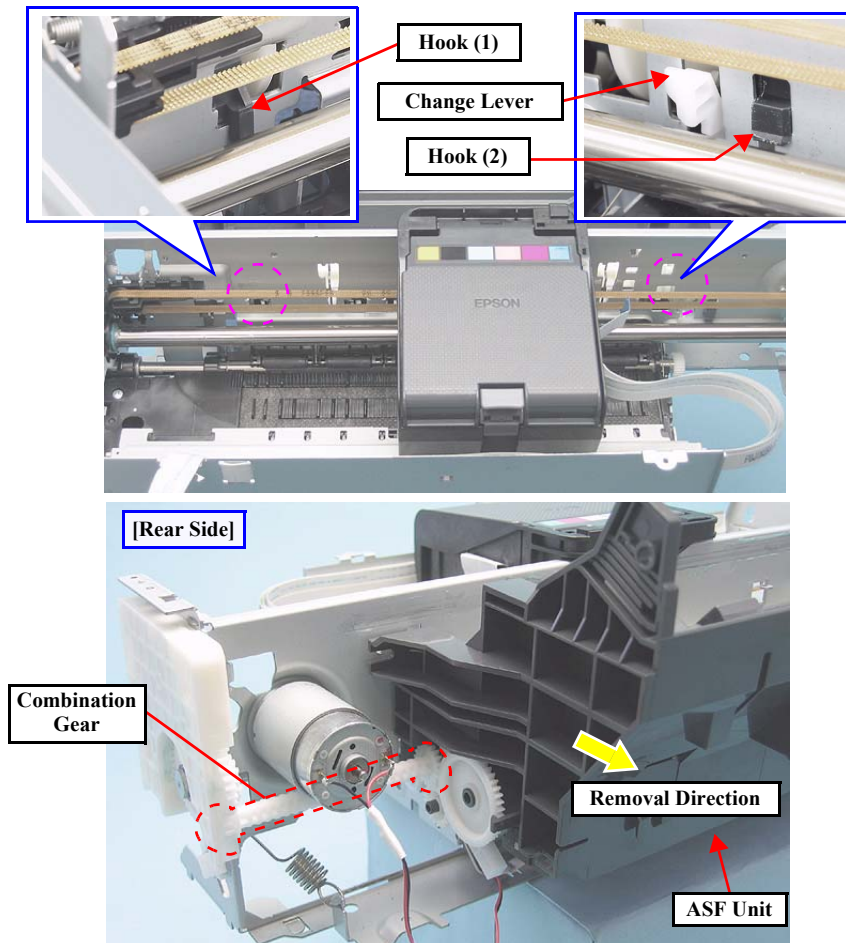

Figure 1-102. Removing the ASF Unit



- Lubrication is required. See the page given below for the lubrication information.
Lubrication of ASF Unit (p.94)
 - When installing the ASF Unit, make sure that the Combination Gear, tip of the Change Lever and the two hooks are securely attached. Also make sure that there is appropriate space at both the left and right of the Change Lever.
 - Tighten the screws in the order given in **Fig.1-101 (p.54)**.
 - Install the LD Roller following the procedure below. Make sure to apply grease referring to the page given below.
Lubrication of the ASF Unit (p.94)
1. Install the LD Roller aligning the arrow on the LD Roller with the arrow on the blade of the shaft. Make sure the LD Roller is securely attached without gap or misalignment.

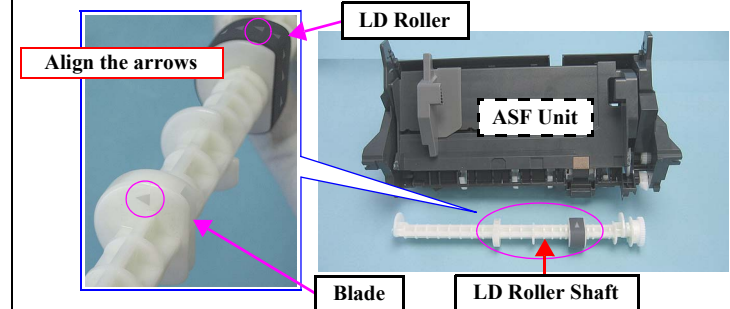

Figure 1-103. Reinstalling the LD Roller



Whenever the ASF Unit is removed or replaced, the required adjustments must be carried out.

- Refer to "2.1.2 Required Adjustments" (p.74)

1.5.15 Upper Paper Guide



- Be sure to follow the procedure below to remove the Upper Paper Guide to avoid damaging the PE Sensor Lever.
- It is recommended to place a transparent sheet between the Upper and Front Paper Guides to avoid scratching the roller.
- Do not touch the roller surface with bare hands as it can adversely affect the print quality.

□ Removal procedure

1. Remove the three springs from the rear side, disengage the three hooks and remove the Upper Paper Guide from the Main Frame.

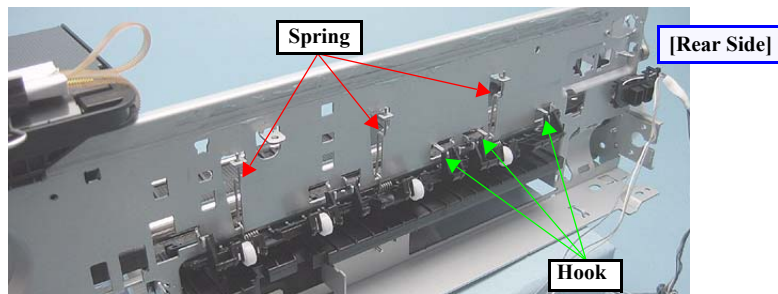



Figure 1-104. Removing the Upper Paper Guide (1)

2. Remove the Upper paper Guide pressing  part to lower the tip of the PE Sensor Lever.

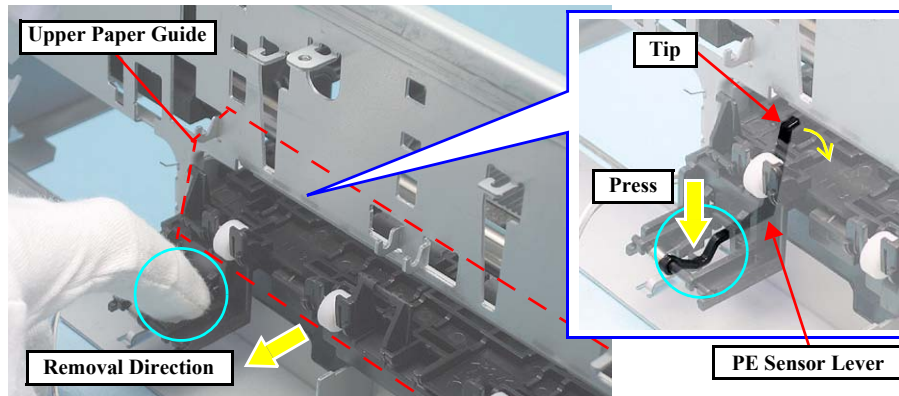
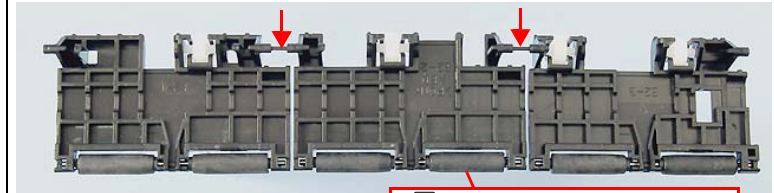

Figure 1-105. Removing the Upper Paper Guide



The figure below is the Upper Paper Guide. The two thin shafts indicated with the arrows are likely to break, however, the Upper Paper Guide does not need to be replaced even if the shafts become broken. Because the shafts do not go on the bushings of the Printer Frame.



Do not touch with bare hands.



When installing the three springs, secure the ends of the springs on the hooks of the Main Frame as shown in Fig.1-106.

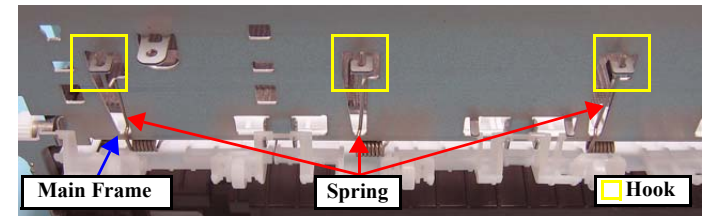

Figure 1-106. Installing the Springs



Whenever the Front Paper Guide Assy is removed or replaced, the required adjustments must be carried out.

- Refer to "2.1.2 Required Adjustments" (p.74)

1.5.16 APG Sensor Assy

□ Removal procedure

1. Disengage the two hooks and remove the APG Sensor Assy.

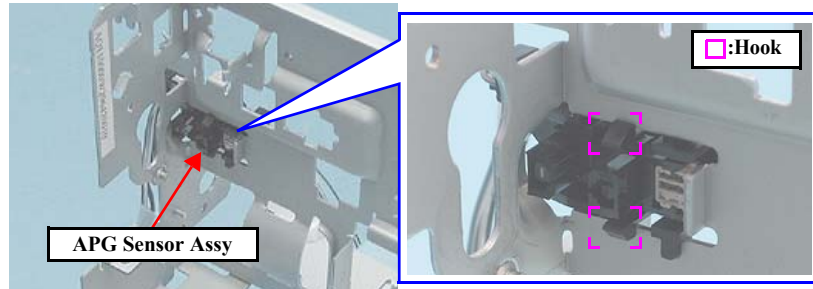

Figure 1-107. Removing the APG Sensor

1.5.17 Front Paper Guide Assy



Do not touch the surface of the rubber roller of the EJ Roller Assy and the coated part of the PF Roller Assy as it can adversely affect the print quality.

□ Removal procedure

1. Remove the screw and remove the Parallelism Bushing L.
 - Screw ○ : C.B.S.(P2) M3x8 (tightening torque: 6-8 kgf.cm)

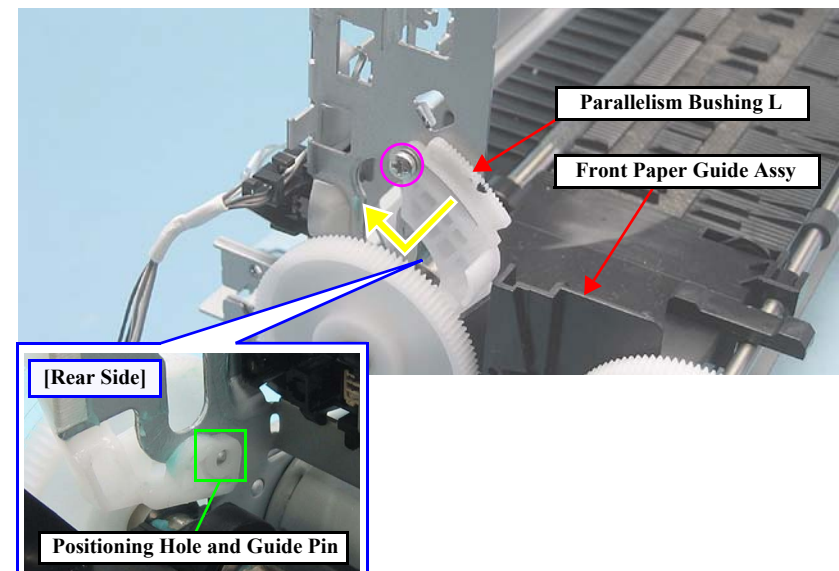

Figure 1-108. Removing the Parallelism Bushing L

2. Disconnect the connector of the PE Sensor Cable on the rear side of the printer.
3. Remove the screw that secures the Front Paper Guide Assy.
 - Screw ○ : C.B.S. M3x6 (tightening torque: 7-9 kgf.cm)

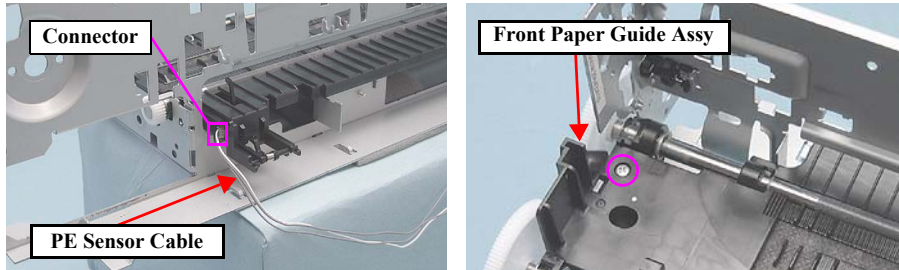

Figure 1-109. Removing the PE Sensor Cable

4. Pull out the EJ Ground Spring to the front side.

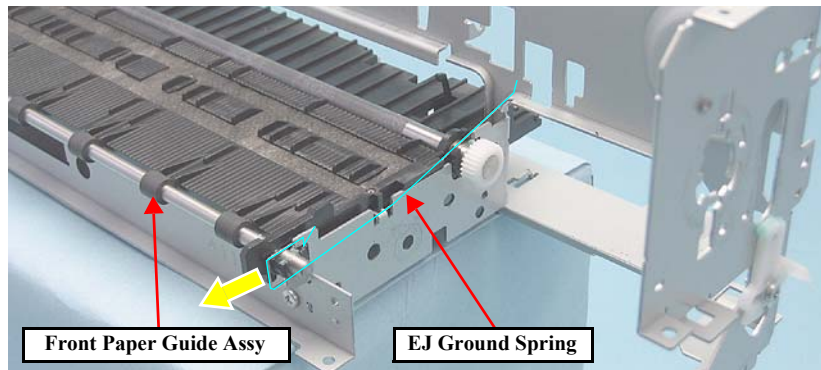

Figure 1-110. Removing the EJ Ground Spring

5. Remove the Front Paper Guide Assy, following the steps below.
 - (1) Lift ○ part to disengage the left side of the Front Paper Guide Assy.
 - (2) Slide the assy leftward little by little to disengage the right side of the assy.
 - (3) Remove the Front Paper Guide Assy while releasing its shaft from the cutout of the rib on the left side of the Main Frame.

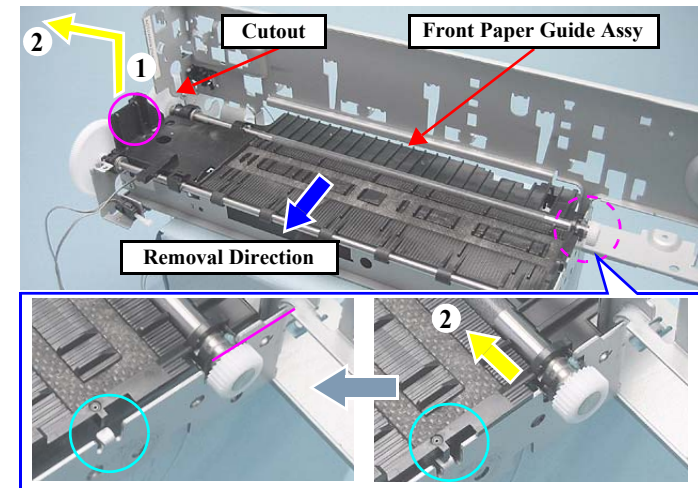

Figure 1-111. Removing the Front Paper Guide Assy



- Lubrication is required. See the page given below for the lubrication information.
[Lubrication of Front Paper Guide Assy \(p.91\)](#)



- When installing the Front Paper Guide Assy, pull out the CDR Tray Sensor cable as shown below.



Figure 1-112. Routing the CDR Tray Sensor Cable

- Attach the long foot of the EJ Ground Spring as follows; (1) put it through the gap under the portion contacts with the EJ Roller, (2) let it contact with the Main Frame, (3) let it contact with the PF Roller shaft, (4) put it through the hole on the frame. When finished, make sure the spring properly contacts with (1), (2), (3), and (4) points.

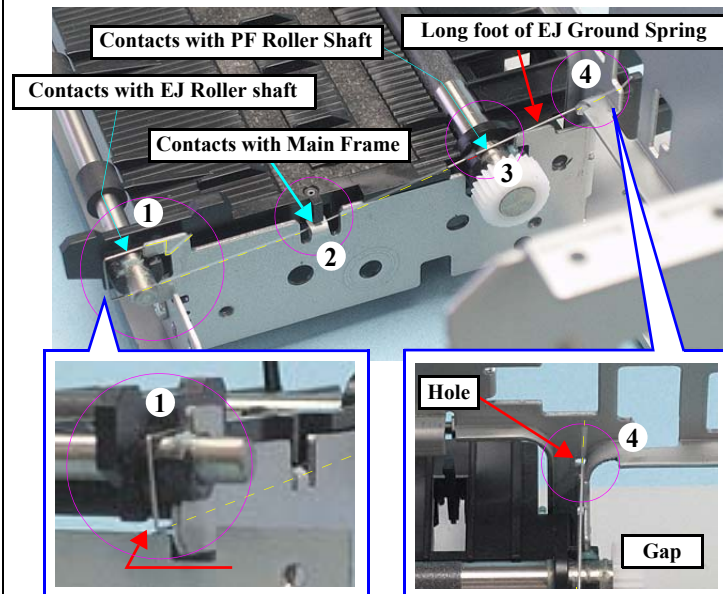

Figure 1-113. Attaching the EJ Ground Spring

- Be careful not to deform the EJ Ground Spring.



- Place the four tips of the Front Paper Guide Pad on the Waste Ink Pad.

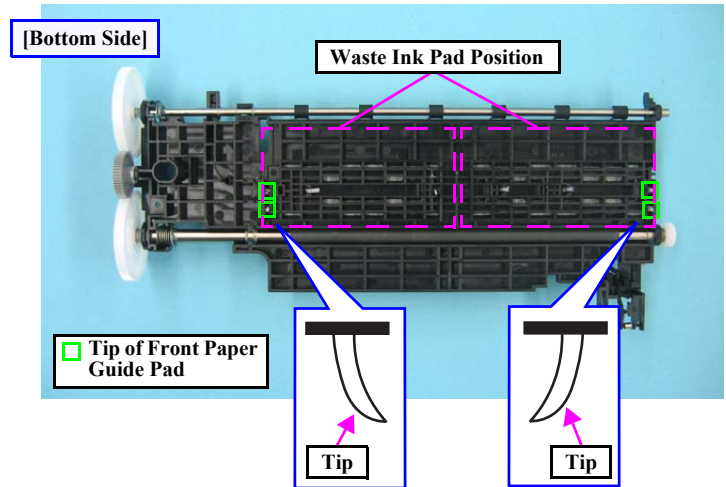

Figure 1-114. Installing Front Paper Guide Pad

- When installing Parallelism Bushing L, match the positioning hole with the guide pin shown in Fig.1-108 (p.57).



- Whenever the Front Paper Guide Assy is removed or replaced, the required adjustments must be carried out.
 - Refer to "2.1.2 Required Adjustments" (p.74)

1.5.18 CDR Tray Sensor

- Removal procedure



Always follow the steps below to remove the CDR Tray Sensor, or one of its hooks can be broken.

1. Disengage the hook of the CDR Tray Sensor.
2. Turn the CDR Tray Sensor 90 degrees in the direction of the arrow to disengage its another hook, and pull it out from the hole to remove it together with the CDR Guide Sensor.

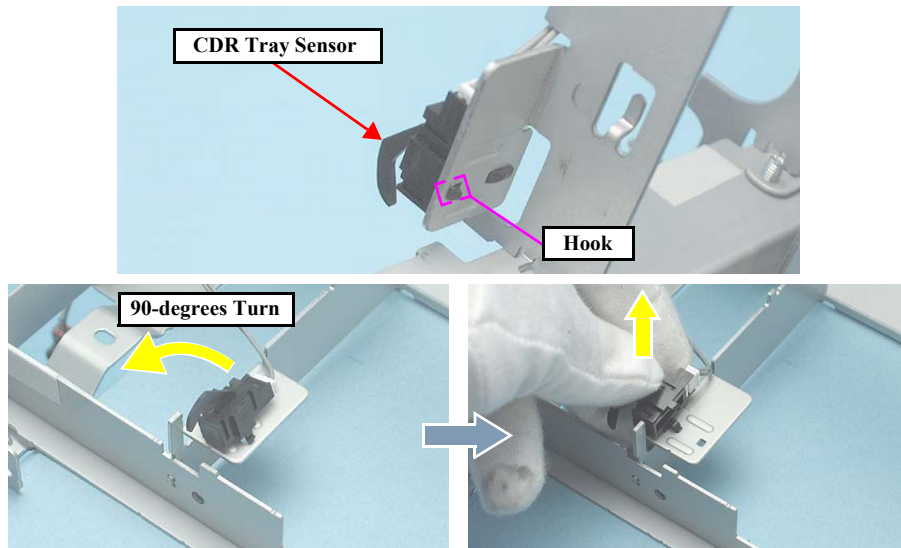
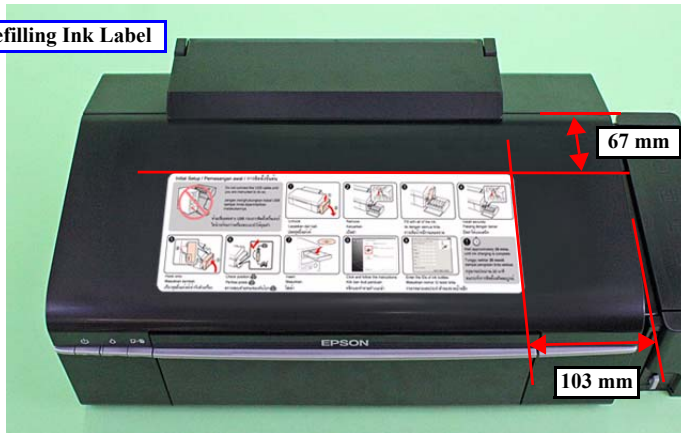

Figure 1-115. Removing the CDR Tray Sensor

1.6 Disassembling the CISS section

1.6.1 Refilling Ink Label / Valve Position Label

Refilling Ink Label



Valve Position Label



Attach the Refilling Ink Label and Valve Position Label according to the standards shown in the figure above.

1.6.2 Top Cover

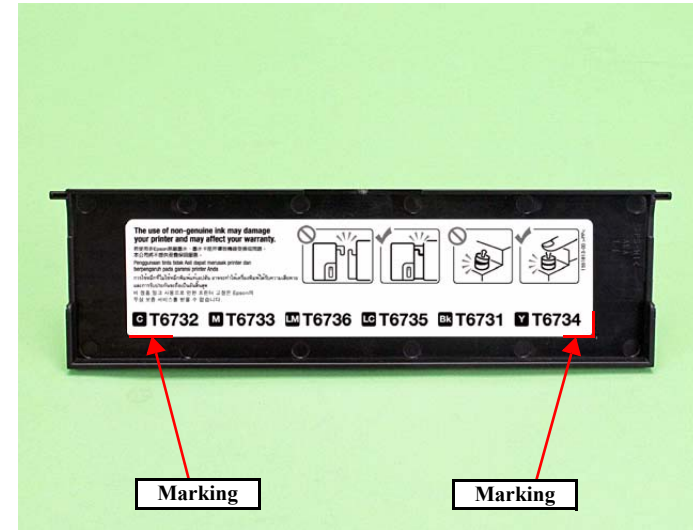

When attaching the Top Cover Label, align it with the markings on the Top Cover as shown in the figure above.

1.6.3 Tube Valve Holder Front / Rear

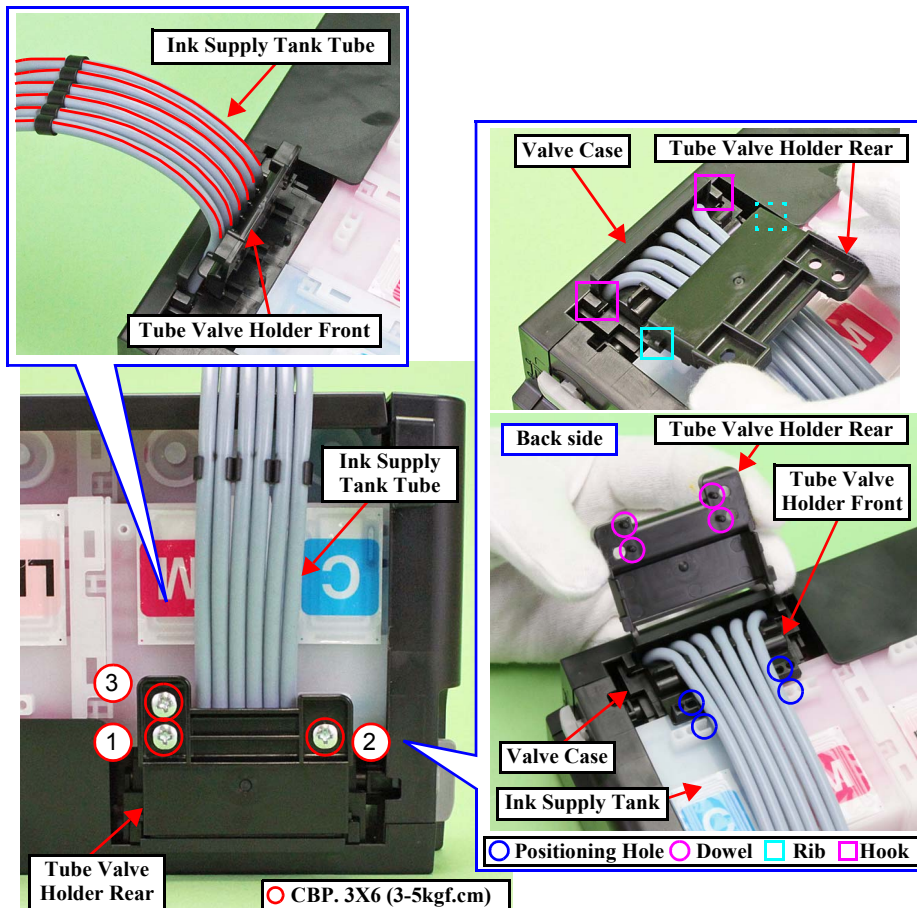

- !** When routing the Ink Supply Tank Tubes, align them with their red lines facing the Tube Valve Holder Front without any twist.
- ↻** Follow the procedure below when installing the Tube Valve Holder Rear.
1. Insert the ribs (x2) of the Tube Valve Holder Rear under the hooks (x2) of the Valve Case.
 2. Align the dowels (x4) of the Tube Valve Holder Rear with the positioning holes (x2) of the Ink Supply Tank and the positioning holes (x2) of the Tube Valve Holder Front.
 3. Make sure no Ink Supply Tank Tubes are caught, then secure it with the screws (x3) in the order shown in the above figure.

1.6.4 Valve Lever

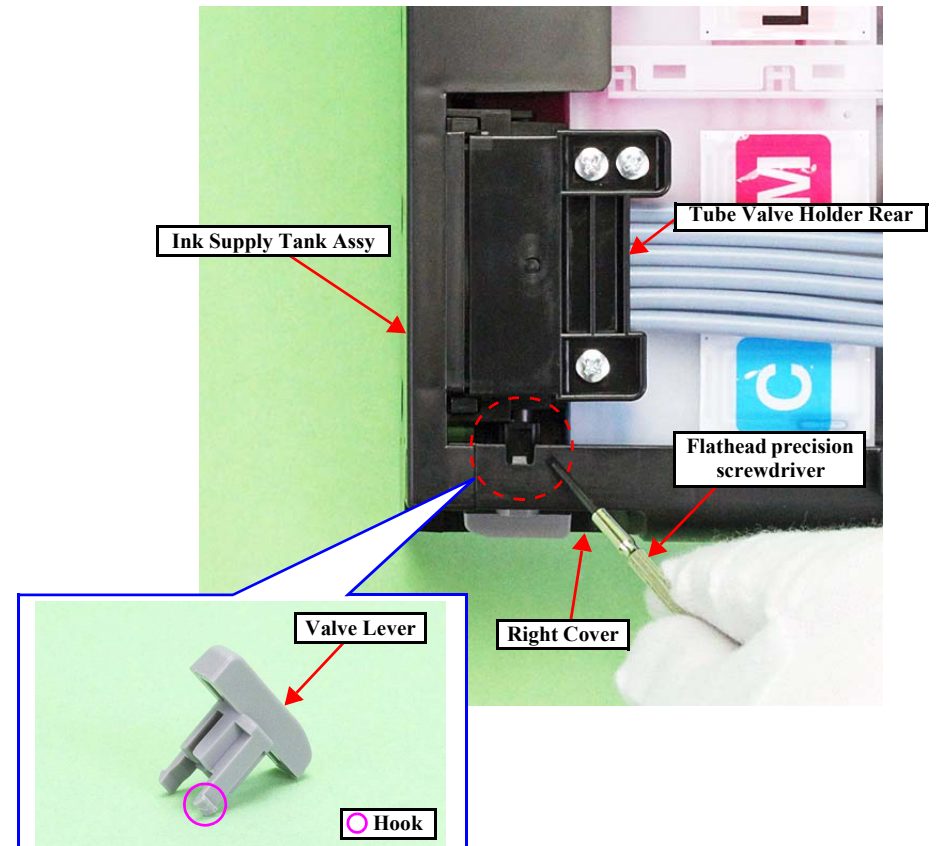

- 🔧** Follow the procedure below when removing the Valve Lever.
1. Remove the Ink Supply Tank Assy from the printer.
 2. Insert a flathead precision screwdriver or the like into the gap between the Right Cover and the Tube Valve Holder Rear to release the hook of the Valve Lever, and then remove the Valve Lever.

1.6.5 Bottom Cover / Left Cover / Right Cover / Cover Joint

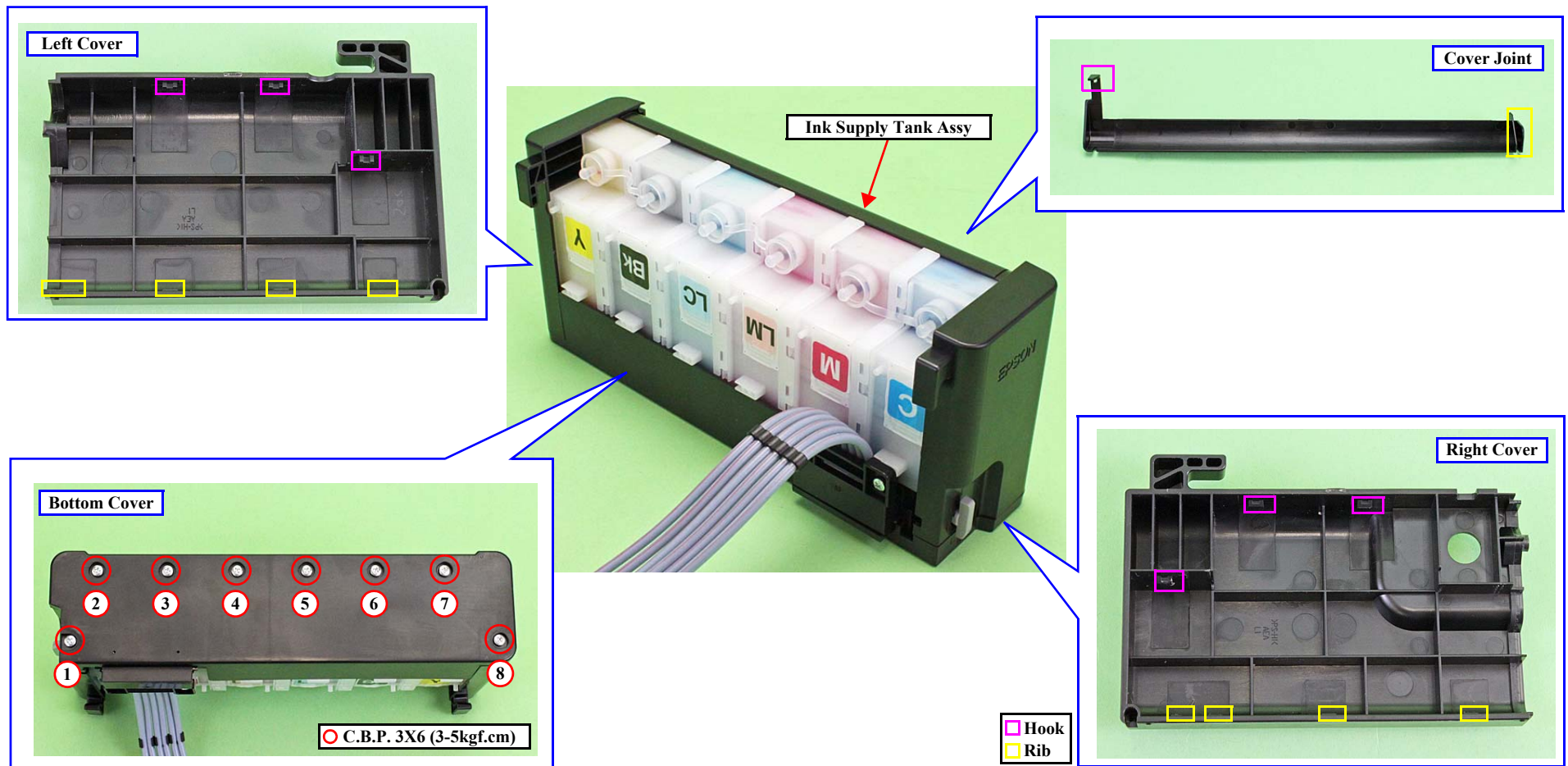

!	Be careful about how to place the Ink Supply Tank Assy in order to prevent printing failure from occurring. (See “How to place the Ink Tank Assy when disassembling/reassembling” (p.10).)
🔧	<ul style="list-style-type: none"> ■ The figures above indicate the hooks and ribs that secure the parts. ■ Remove the exterior parts of the Ink Supply Tank Assy in the following order. <ol style="list-style-type: none"> 1. Remove the screws (x8) of the Bottom Cover, and remove the Bottom Cover. 2. Remove the Left Cover and Right Cover. 3. Remove the Cover Joint.
↻	Tighten the screws in the order indicated in the figure above.

1.6.6 Ink Supply Tank Assy

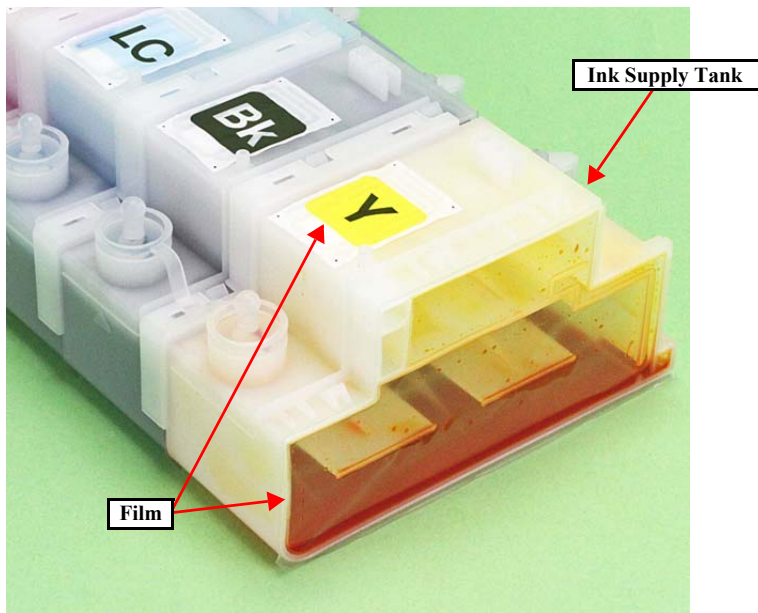

- ! Be careful not to damage or peel off the film of the Ink Supply Tank.
- Be careful about how to place the Ink Supply Tank Assy in order to prevent printing failure from occurring. (See “How to place the Ink Tank Assy when disassembling/reassembling” (p.10).)

1.6.7 Ink Supply Tank Tube Assy

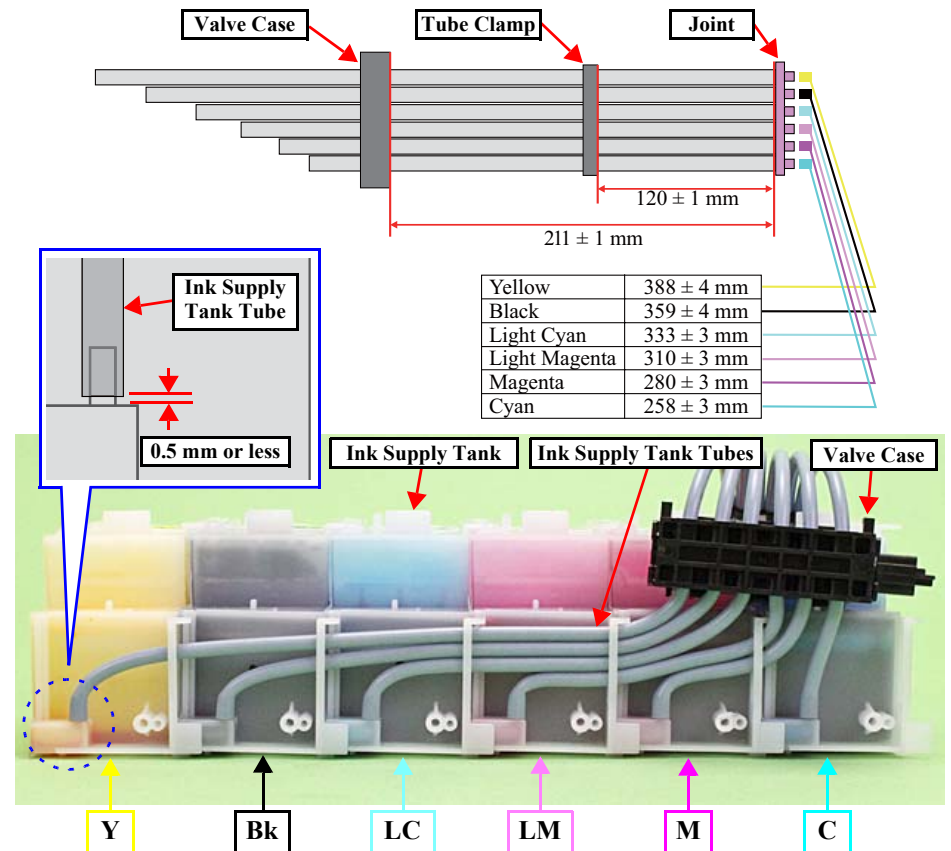

- ➡ Route the Ink Supply Tank Tubes with the red lines facing upward (as viewed when the Ink Supply Tank Assy is installed on the printer) and connect them to the Ink Supply Tank Assy without any twist.
- When connecting the Ink Supply Tank Tubes to the Ink Supply Tank, confirm the color indicated on the film of the Ink Supply Tank, and take care not to connect them with wrong joints.
- When connecting the Ink Supply Tank Tubes to the Ink Supply Tank, insert the tubes to the full and make sure the gaps between the end of tubes and the tank are 0.5 mm long or less.

1.6.8 Joint

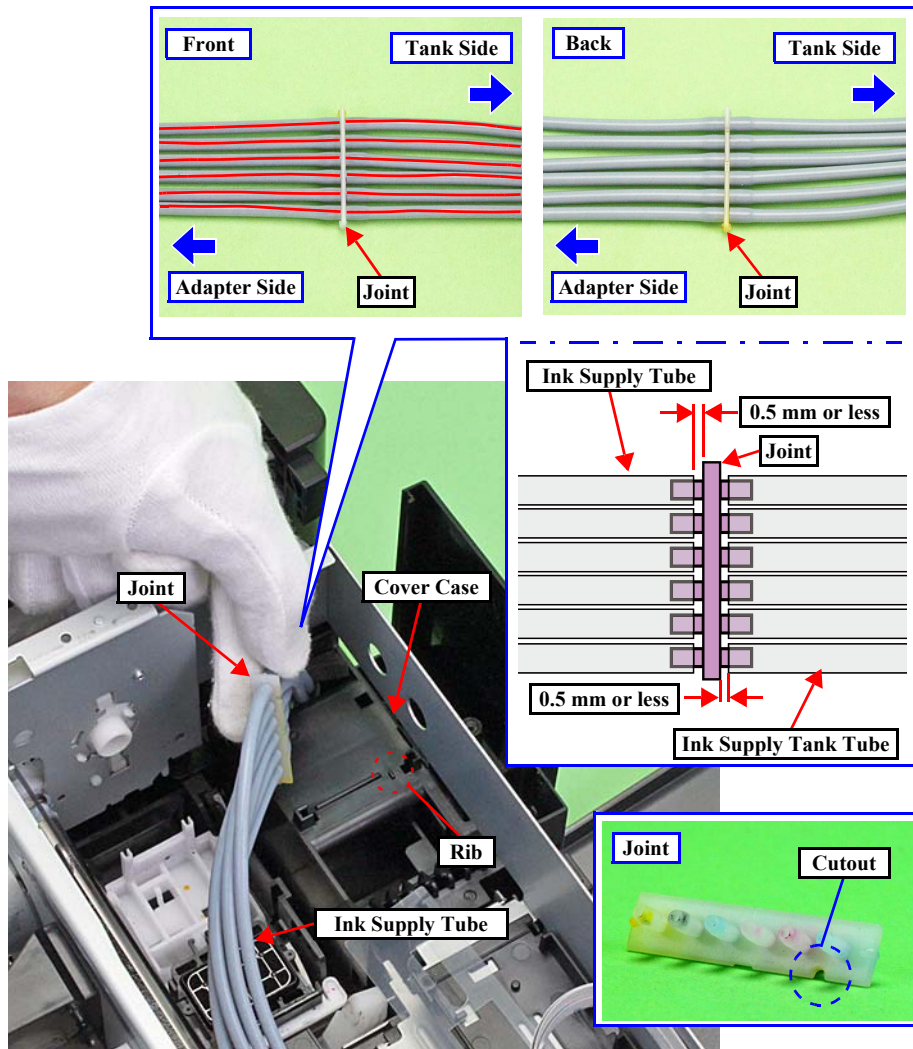

- Make sure the red lines of the Ink Supply Tank Tube and Ink Supply Tube facing upward.
- When attaching the Joint, align the cutout of the Joint with the rib of the Cover Case.
- Make sure the gaps between the end of Ink Supply Tank Tubes or Ink Supply Tubes and the Joint are 0.5 mm long or less.

1.6.9 Cover Case

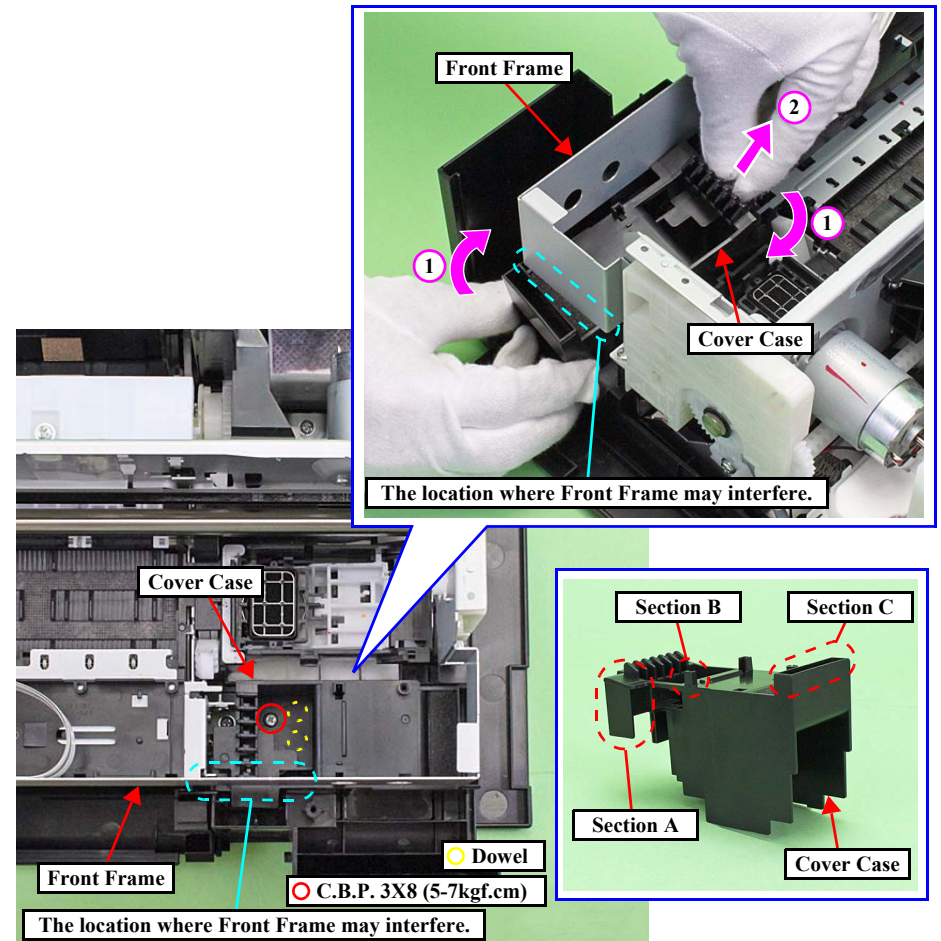

- !** Be careful not to damage the Cover Case with the edges of the front frame.
- 🔧** Follow the procedure below when removing the Cover Case.
1. Remove the screw (x1).
 2. Lift the Cover Case slightly to release the dowels (x2) on the bottom of the Cover Case.
 3. Rotate the Cover Case in the direction of the arrow (1) to avoid the section A and B of the Cover Case from bumping against the Front Frame.
 4. Remove the Cover Case in the direction of the arrow (2) while avoiding the section C of the Cover Case from bumping against the Front Frame.

1.6.10 PF Scale Cover / PF Scale Sheet

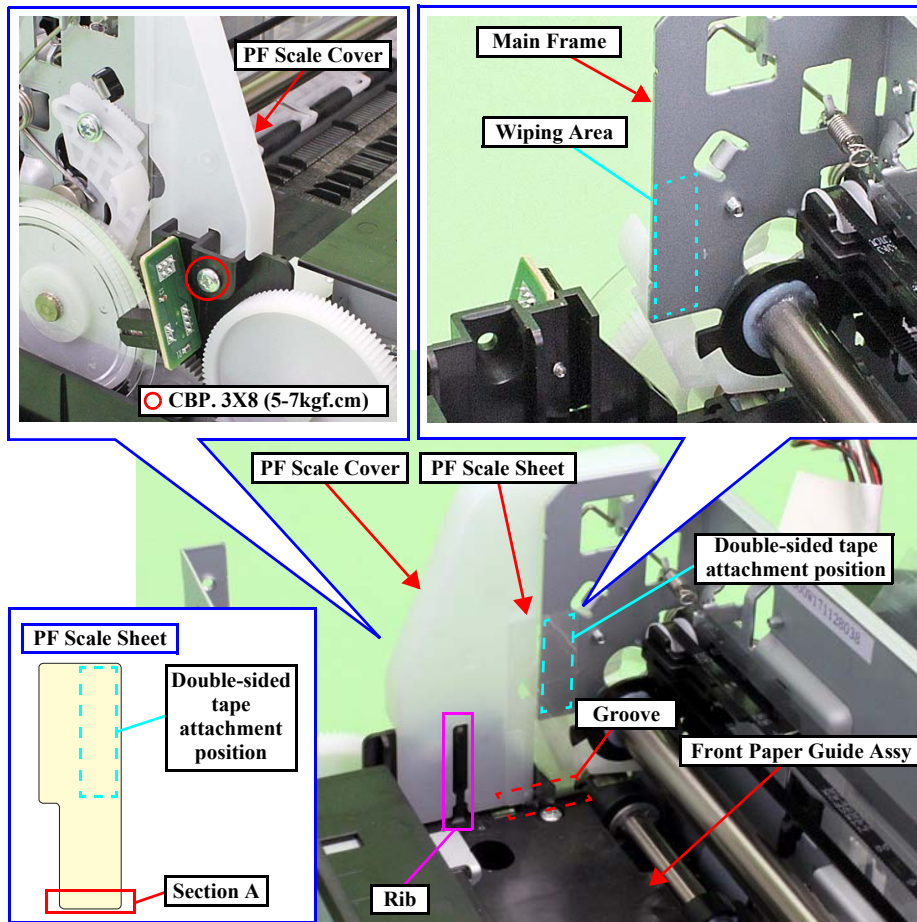

- Follow the procedure below when attaching the PF Scale Cover/PF Scale Sheet.
1. Wipe off the area on the Main Frame shown above using a cloth moistened with alcohol.
 2. Align the PF Scale Cover with the rib of the Front Paper Guide Assy, and attach the PF Scale Cover.
 3. Align the screw holes of the PF Scale Cover and Front Paper Guide Assy, and secure the PF Scale Cover with the screw (x1).
 4. After the alcohol dried out completely, insert the section A of the PF Scale Sheet into the groove of the Front Paper Guide Assy, and then attach it with double-sided tape.

1.6.11 Tube Guide Sheet / Tube Guide Sheet Sub

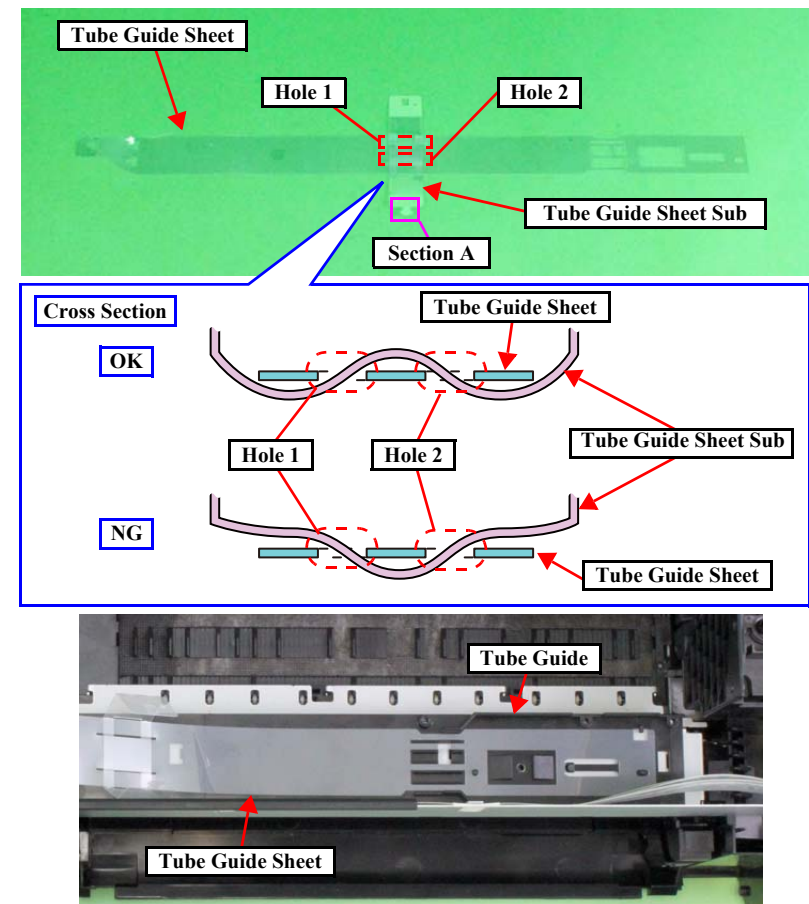

- Refer the figure above and follow the procedure below when attaching the Tube Guide Sheet Sub to the Tube Guide Sheet.
1. Insert the section A of the Tube Guide Sheet Sub into the hole 1 of the Tube Guide Sheet from the bottom.
 2. Insert the section A of the Tube Guide Sheet Sub into the hole 2 of the Tube Guide Sheet from the top.
- When attaching the Tube Guide Sheet to the Tube Guide, while keeping the Tube Guide Sheet Sub attached on the Tube Guide Sheet, align the holes of the Tube Guide Sheet with the protrusions of the Tube Guide.

1.6.12 Ink Supply Tube Assy

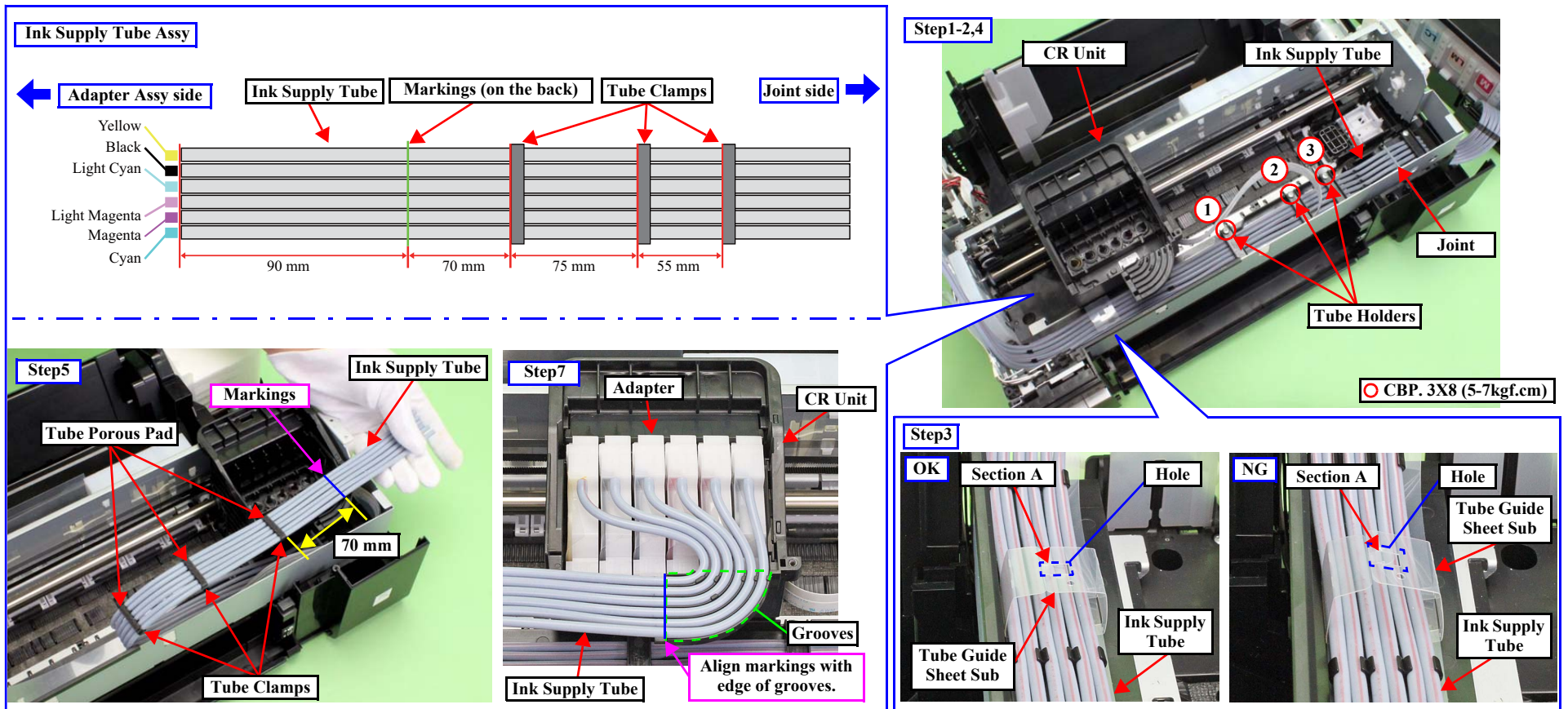

! Make sure the Tube Clamps (with Porous Pad Tube attached) (x3) are attached on the positions on the Ink Supply Tube shown above.

- ➡** Follow the procedure below when installing the Ink Supply Tube Assy.
1. Place the Ink Supply Tube onto the Tube Guide Sheet with its Tube Porous Pad side down.
 2. Connect the Ink Supply Tubes (x6) to the Joint.
 3. Insert the section A of the Tube Guide Sheet Sub from the top into the hole of the Tube Guide Sheet Sub to secure it.
 4. Attach the Tube Holders (x3) and secure them with the screws in the order shown in the figure above.
 5. Hold the Ink Supply Tube by the Adapter side and flip it over as shown in the figure, then put a marking on the bottom side of the Ink Supply Tube 70 mm from the Tube Clamp nearest to the Adapter.
 6. Connect the Ink Supply Tube to the Adapter, and install the Adapter to the CR Unit. (p.68)
 7. Route the Ink Supply Tubes through the grooves of the CR Unit, and align the markings on the Ink Supply Tubes with the edge of the grooves as shown in the figure above.

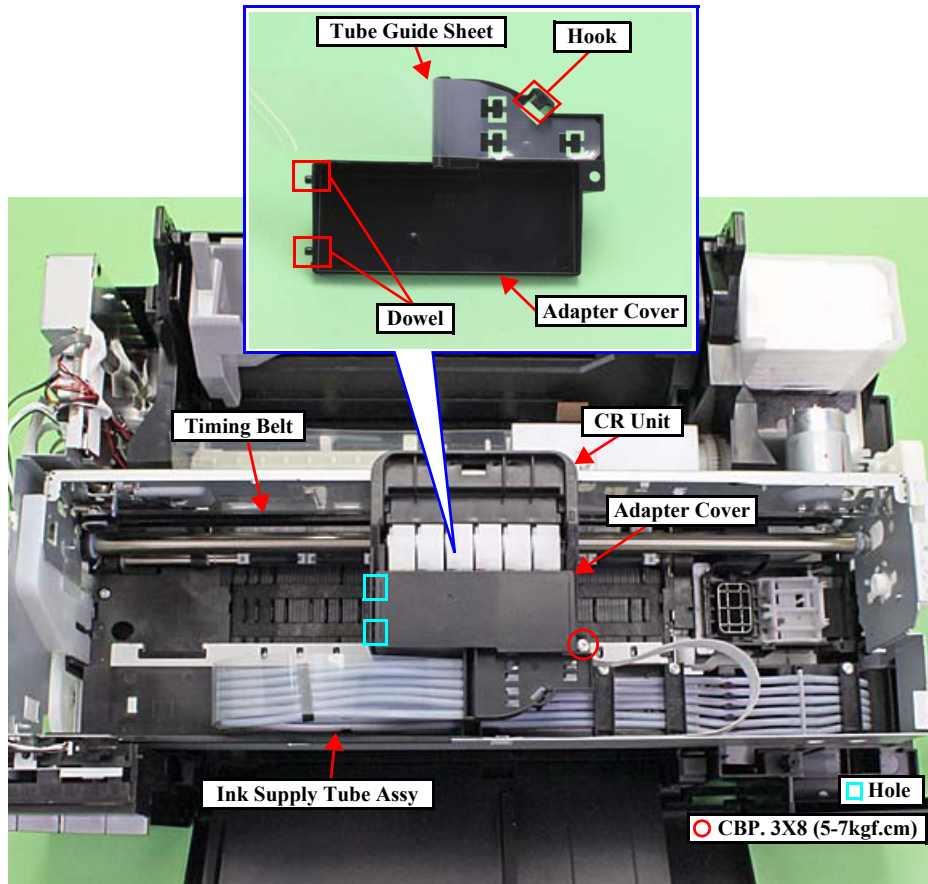

1.6.13 Adapter Cover

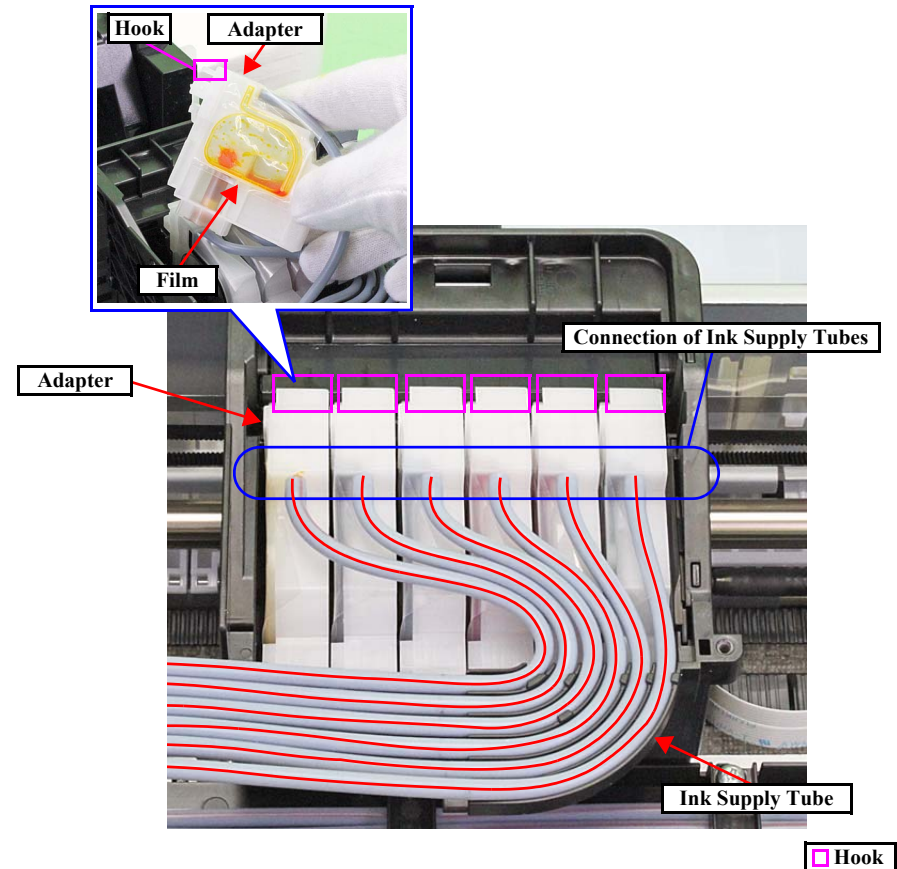

- 
 - Follow the procedure below when installing the Adapter Cover to the CR Unit.
 1. Attach the Tube Guide Sheet to the Adapter Cover.
 2. Insert the dowels (x2) of the Adapter Cover into the holes (x2) of the CR Unit and engage the hook of the Adapter Cover to the CR Unit.
 3. Make sure no Ink Supply Tubes are caught, then secure the Adapter Cover with the screw (x1).
 - After installing the Adapter Cover to the CR Unit, move the CR Unit from side to side while holding the Timing Belt to make sure that the Ink Supply Tube Assy does not apply extra load of the CR Unit movement.

1.6.14 Adapter



- 
 - ! Be careful not to damage or peel off the film of the Adapter.
- 
 - Use a precision screwdriver when releasing the hooks of the Adapter.
- 
 - When connecting the Ink Supply Tubes to the Adapter, make sure the red lines on the Ink Supply Tubes are facing upward as shown in the figure above.

CHAPTER

2

ADJUSTMENT

2.1 Adjustment Items and Overview

This chapter describes adjustments necessary after the disassembly/reassembly of the printer.

2.1.1 Servicing Adjustment Item List

The adjustment items of this product are as follows.



- For information on how to carry out the adjustments and media required for the adjustments, see the instructions displayed by the Adjustment Program.
- Some pictures in this manual are for Epson Stylus Photo R280/R285/R290; therefore, the shapes of the parts are different from those of L800/L801, but the differences does not affect the adjustment procedures.

Table 2-1. Adjustment Items

Adjustment Item	Purpose	Method Outline	Tool
PG adjustment	Install the Head Nozzle surface parallel to the printing surface and set the gap between the paper and the Head Nozzle surface to the specified value.	Mechanical adjustment using the thickness gauges. Make a proper adjustment according to the result whether the manually-moved carriage (printhead) runs over or hits against the gauges placed on the platen.	• Thickness Gauge 1.15 mm, 1.3 mm
EEPROM data copy	When the main board needs to be replaced, use this to copy adjustment values stored on the old main board to the new board. If this copy is completed successfully, all the other adjustments required after replacing the main board are no longer be necessary.	Readout the EEPROM data from the main board before removing it. Then replace the board with a new one, and load the EEPROM data to the new board.	• Adjustment Program
Initial setting	This must be carried out after replacing the main board to apply settings for the target market. When this function is performed, the upper limit value of the ink tube counter is automatically set. With this function, the serial number written on the main board can be checked, and also writing the serial number to the main board can be performed when replacing the board.	Select the target market. The selected market settings are automatically written to the main board. When writing the serial number, enter and re-enter (for confirmation) the printer serial number, then press the input button.	• Adjustment Program
Head ID input	This must be carried out after replacing the printhead in order to enter the new printhead ID (Head ID) that reduces variation between printheads.	Enter the ID printed on the Head QR code label attached on the printhead. The correction values are automatically written to the main board.	• Adjustment Program
Initialize PF deterioration offset	Resets the counter to maintain paper feed accuracy which decreases due to paper dust.	Reset the counter to its default.	• Adjustment Program
Disenable PF deterioration offset	When reading the counter value from the old main board is impossible in the case of replacing the board, use this to set the counter to its maximum value.	Set the counter to its maximum value (3000).	• Adjustment Program
TOP margin adjustment	This corrects top margin of printout.	A top margin adjustment pattern is printed. Examine the lines printed near the top edge of the printout, and enter the value for the line that is exactly 3 mm away from the top edge.	• Adjustment Program • Ruler

Table 2-1. Adjustment Items

Adjustment Item	Purpose	Method Outline	Tool
Head angular adjustment	This must be carried out after replacing the printhead in order to correct tilt of the printhead by software.	A head angular adjustment pattern is printed. Examine the printed lines and enter the value for the most straight lines.	• Adjustment Program
Bi-D adjustment	Corrects print start timing in bi-directional printing to improve the print quality.	A Bi-D adjustment pattern is printed. Examine the patterns and enter the value for the pattern with no gap and overlap for each mode.	• Adjustment Program
First dot position adjustment	Corrects left margin of printout. The print start position in the carriage moving direction is corrected by software.	A first dot adjustment pattern is printed. Examine the lines printed near the left edge of the printout and enter the value for the line that is exactly 5 mm away from the left edge.	• Adjustment Program • Ruler
PW adjustment	This adjustment is made to correct the mounting position of the PW Sensor on a software basis to adjust the detection position and Nozzle position dispersion.	A PW adjustment pattern is printed. Examine the printout patterns and enter the value for the line that is exactly 5mm away from the paper edge for each of the left, right, top and bottom.	• Adjustment Program
PF adjustment	Corrects variations in paper feed accuracy when using the Microweave to achieve higher print quality.	A PF adjustment pattern is printed. Examine the printout patterns and select the value for the best pattern. The correction value is registered.	• Adjustment Program
BRS/PFP adjustment	This adjustment is made to ensure high print quality at high print speed.	Print the adjustment pattern to be scanned by a specified scanner. According to the scanned result, a correction value is automatically calculated and stored into the serial flash ROM on the main board. The correction value is applied when printing in the corresponding mode. For some scanners, two PFP base scales are required. See “ 2.3 Banding Reduction System (BRS) Adjustment / Paper Feed Amount Profile (PFP) Correction (p. 83) ”.	• Specified Scanner • PFP base scale
CR motor heat protection control	This must be carried out for efficient heat control of the CR motor. Electrical variation of the motor and the power supply board are measured to acquire correction values for them.	Select the parts that you replaced. The correction values are automatically written to the main board.	• Adjustment Program

Table 2-2. Maintenance Items

Maintenance Item	Purpose	Method Outline	Tool
Head cleaning	This function is used to execute Cleaning efficiently when ink is not delivered from the Head properly, e.g. dot missing.	The cleaning can be selected from the normal cleaning or the power cleaning. Whether to reflect the discharged ink amount to the waste ink pad counter or not can also be selected as an option. The head cleaning is performed automatically. After the cleaning, print a nozzle check pattern to check if all nozzles are firing ink properly.	• Adjustment Program
Maintenance counter	The printer causes a maintenance error when the maintenance counter (for the Waste Ink Tray, Waste Ink Pad Lower) reaches its maximum. Use this to reset the counter after replacing the Waste Ink Pad and Waste Ink Pad Lower, and use this to reset the ink tube counter when replacing the Ink Supply Tube. If you find the counter is close to the maximum during servicing, carry out the pad replacement and the counter reset to avoid the printer returned from the user due to the maintenance error.	Select the replaced parts, and reset the corresponding counters.	• Adjustment Program
Ink charge	This function is used to charge ink to the components composing the ink path such as Printhead after replacing them.	The ink charge can be selected from the charge to Printhead only or the charge through Ink Tube, Adapter to Printhead. Whether to reflect the discharged ink amount to the waste ink pad counter or not can also be selected as an option. Select the range to charge ink and options, and then press the execute button to execute the ink charge to the selected range automatically. After ink charge, print a nozzle check pattern to check if all nozzles are firing ink properly.	• Adjustment Program
Small ink counter reset	When an ink out error occurs even though some ink is still in the Ink Supply Tank Assy (in the case when the ink counter in the printer and the actual ink remaining amount do not match), this function can decrease the ink counter (resetting the counter partially) to adjust the counter with the actual ink remaining amount.	If the execute button is pressed, the ink counter value is automatically set. But if no ink out error is occurring, the message which says the function cannot be executed appears and no reset will be made.	• Adjustment Program

Table 2-3. Additional Functions

Additional Functions		Purpose	Method Outline	Tool
Final check pattern print	A4 size	Use this to check if the all adjustments have been properly made.	The all adjustment patterns are printed automatically.	• Adjustment Program
	US Letter size			
EEPROM dump		Use this to readout the EEPROM data for analysis.	The all EEPROM data is automatically readout and stored as a file.	• Adjustment Program

Table 2-3. Additional Functions

Additional Functions		Purpose	Method Outline	Tool
Printer information check	Manual CL counter	Use this to readout information on the printer operations.	The printer information is automatically readout.	• Adjustment Program
	I/C change CL counter			
	Timer CL counter			
	Total print path counter			
	Total print page counter			
	CD-R print counter			
	1st TI received time			
	Latest fatal error code			
	ROM version			
	Ink bottle counter			

2.1.2 Required Adjustments

The table below lists the required adjustments depending upon the parts being repaired or replaced. Find the part(s) you removed or replaced, and check which adjustment(s) must be carried out.

Note : <Meaning of the marks in the table>

“O” indicates that the adjustment must be carried out. “O*” indicates that the adjustment is recommended. “---” indicates that the adjustment is not required.

If you have removed or replaced multiple parts, make sure to check the required adjustments for the all parts. And when multiple adjustments must be carried out, be sure to carry out them in the order given in the “Priority” row.

Table 2-4. Adjustment Items

Priority		1	2	3	4	5	6	7	8	9	10	11	12	13	14	15	16	17
Adjustment Item	Part Name	PG adjustment	EEPROM data copy	Initial setting	Head ID input	Maintenance counter	Ink charge	Initialize PF deterioration offset	Disable PF deterioration offset	Top margin adjustment	Head angular adjustment	Bi-D adjustment	First dot position adjustment	PW adjustment	PF adjustment	BRS adjustment	PPF adjustment	CR motor heat protection control
		ASF Unit	Remove	--	--	--	--	--	--	--	--	O	--	--	O	--	O	--
	Replace	--	--	--	--	--	--	--	--	O	--	--	O	--	O	--	O	--
CR Motor	Remove	--	--	--	--	--	--	--	--	--	--	O*	--	--	--	--	--	--
	Replace	--	--	--	--	--	--	--	--	--	--	O*	--	--	--	--	--	O
Upper Paper Guide	Remove	--	--	--	--	--	--	--	--	O	--	--	--	--	O	O	O	--
	Replace	--	--	--	--	--	--	--	--	O	--	--	--	--	O	O	O	--
Printhead	Remove	O	--	--	--	--	--	--	--	O	O	O	O	O	O	O	O	--
	Replace	O	--	--	O	--	O	--	--	O	O	O	O	O	O	O	O	--
Main Board	Remove	--	--	--	--	--	--	--	--	--	--	--	--	--	--	--	--	--
	Replace (Read OK)	--	O	--	--	--	--	--	--	--	--	--	--	--	--	--	--	O
	Replace (Read NG)	--	--	O	O	O (Ink Pads must be replaced)	--	--	O	O	O	O	O	O	O	O	O	O
P/S Assy	Remove	--	--	--	--	--	--	--	--	--	--	--	--	--	--	--	--	--
	Replace	--	--	--	--	--	--	--	--	--	--	--	--	--	--	--	--	O

Table 2-4. Adjustment Items

Priority		1	2	3	4	5	6	7	8	9	10	11	12	13	14	15	16	17	
Adjustment Item	Part Name	PG adjustment	EEPROM data copy	Initial setting	Head ID input	Maintenance counter	Ink charge	Initialize PF deterioration offset	Disable PF deterioration offset	Top margin adjustment	Head angular adjustment	Bi-D adjustment	First dot position adjustment	PW adjustment	PF adjustment	BRS adjustment	PPF adjustment	CR motor heat protection control	
		Front Paper Guide Assy (including PF Shaft)	Remove	O	--	--	--	--	--	--	--	O	O	O	O	O	O	O	O
	Replace	O	--	--	--	--	--	--	O	O	O	O	O	O	O	O	O	O	--
PF Motor	Remove	--	--	--	--	--	--	--	--	--	--	--	--	--	--	--	--	--	--
	Replace	--	--	--	--	--	--	--	O	--	--	--	--	--	--	--	--	--	--
Waste Ink Tray	Remove	--	--	--	--	--	--	--	--	--	--	--	--	--	--	--	--	--	--
	Replace	--	--	--	--	O (Waste Ink Tray)	--	--	--	--	--	--	--	--	--	--	--	--	--
Waste Ink Pad Lower	Remove	--	--	--	--	--	--	--	--	--	--	--	--	--	--	--	--	--	--
	Replace	--	--	--	--	O (Waste Ink pad)	--	--	--	--	--	--	--	--	--	--	--	--	--
CR Unit	Remove	O	--	--	--	--	--	--	--	O	O	O	O	O	O	O	O	O	O
	Replace	O	--	--	--	--	--	--	--	O	O	O	O	O	O	O	O	O	O
EJ Frame Assy	Remove	--	--	--	--	--	--	--	--	--	--	--	--	--	O	O	O	O	--
	Replace	--	--	--	--	--	--	--	--	--	--	--	--	--	O	O	O	O	--
Ink Supply Tube Assy	Remove	--	--	--	--	--	O	--	--	--	--	--	--	--	--	--	--	--	--
	Replace	--	--	--	--	O	O	--	--	--	--	--	--	--	--	--	--	--	--
Ink Supply Tube Tank Assy	Remove	--	--	--	--	--	O	--	--	--	--	--	--	--	--	--	--	--	--
	Replace	--	--	--	--	--	O	--	--	--	--	--	--	--	--	--	--	--	--
Adapter	Remove	--	--	--	--	--	O	--	--	--	--	--	--	--	--	--	--	--	--
	Replace	--	--	--	--	--	O	--	--	--	--	--	--	--	--	--	--	--	--
Ink Supply Tank	Remove	--	--	--	--	--	O	--	--	--	--	--	--	--	--	--	--	--	--
	Replace	--	--	--	--	--	O	--	--	--	--	--	--	--	--	--	--	--	--

Table 2-4. Adjustment Items

Priority		1	2	3	4	5	6	7	8	9	10	11	12	13	14	15	16	17
Part Name	Adjustment Item	PG adjustment	EEPROM data copy	Initial setting	Head ID input	Maintenance counter	Ink charge	Initialize PF deterioration offset	Disable PF deterioration offset	Top margin adjustment	Head angular adjustment	Bi-D adjustment	First dot position adjustment	PW adjustment	PF adjustment	BRS adjustment	PPF adjustment	CR motor heat protection control
	Joint	Remove	--	--	--	--	--	O	--	--	--	--	--	--	--	--	--	--
Replace		--	--	--	--	--	O	--	--	--	--	--	--	--	--	--	--	--
Printer Mechanism	Remove	--	--	--	--	--	O	--	--	--	--	--	--	--	--	--	--	--
	Replace	O	--	--	--	--	O	O	--	O	O	O	O	O	O	O	O	O

2.2 Using the Adjustment Program

This section describes how to judge the adjustment patterns printed by the Adjustment Program. For information on how to operate the Adjustment Program, see the instructions displayed by the Adjustment Program.

2.2.1 Top Margin Adjustment

Patterns are printed as shown below.

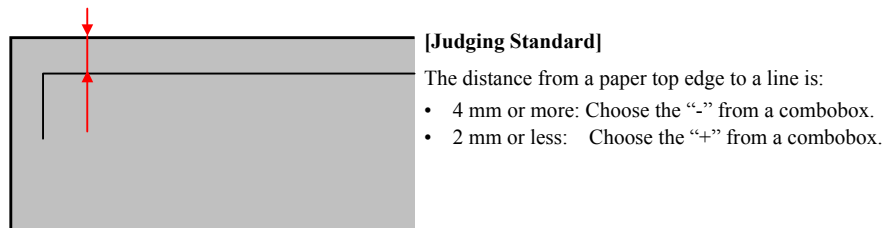

Figure 2-1. Top Margin Adjustment Pattern

How to Judge

Measure the distance from the top edge of paper to the printed line, and enter any one of the “-”, “0”, “+” according to the judging standard.

2.2.2 Head Angular Adjustment

Two patterns are printed as shown below.

Band pattern

The following pattern is printed. The lines below “0 >> 80” are printed while the carriage moves from the home to the other side, and lines below “80 >> 0” are printed while the carriage returns to the home.

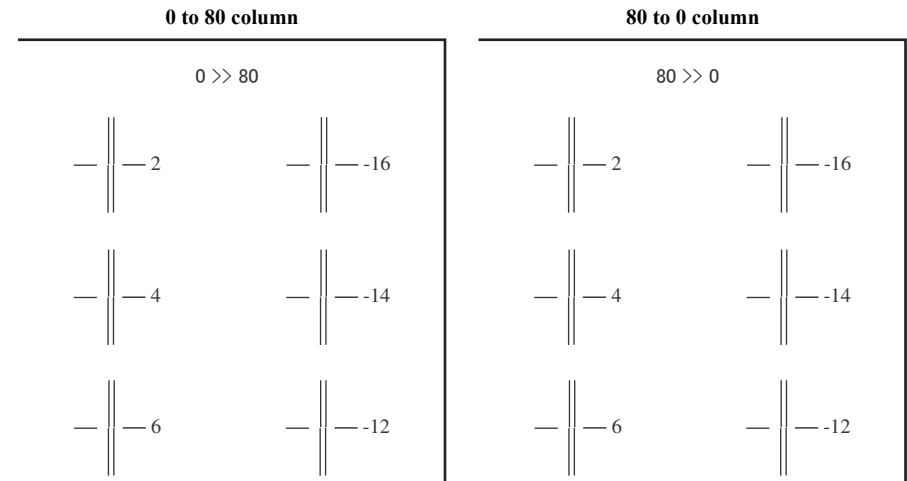

Figure 2-2. Head Angular Adjustment (Band) Pattern

How to Judge

Examine the printout patterns and enter the value (-16 to 16) for the most straight lines.

Additional information

When “16” or “-16” is the most straight lines, it indicates that the printhead is not installed correctly. Reassemble the printhead and carry out this adjustment again.

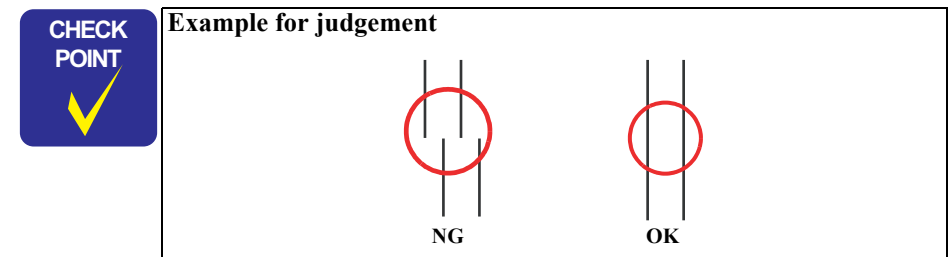

□ Microweave Pattern

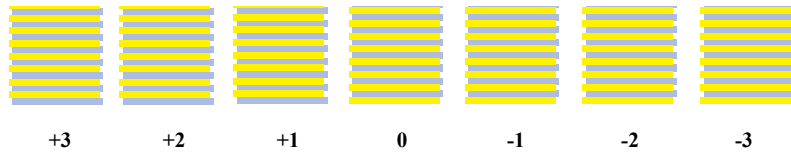

Figure 2-3. Head Angular Adjustment (Microweave) Pattern

How to Judge

Examine the printout +3 to -3 patterns and select the value for the group of which the gaps between the 2 color bars are the smallest.

Additional information

If no appropriate pattern is found, reassemble/replace the Printhead.

CHECK
POINT

Example for judgement

OK

NG

2.2.3 Bi-D Adjustment

The pattern shown below is printed for each of the 7 print modes.

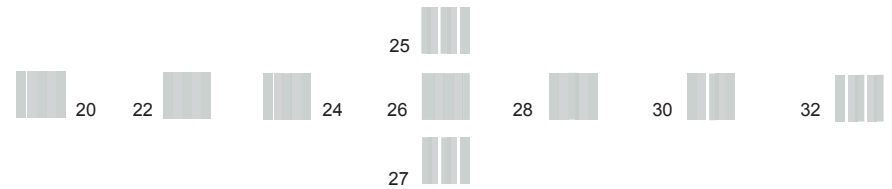

Figure 2-4. Bi-D Adjustment Pattern

How to Judge

Find the pattern with no gaps or overlaps of the left and right pattern, and enter the value of that pattern.

Additional information

If an appropriate pattern is not printed, enter the nearest value and then print the patterns again.

CHECK
POINT

Example for judgement

NG

OK

NG

2.2.4 PW Adjustment/First Dot Position Adjustment

Patterns are printed as shown below.

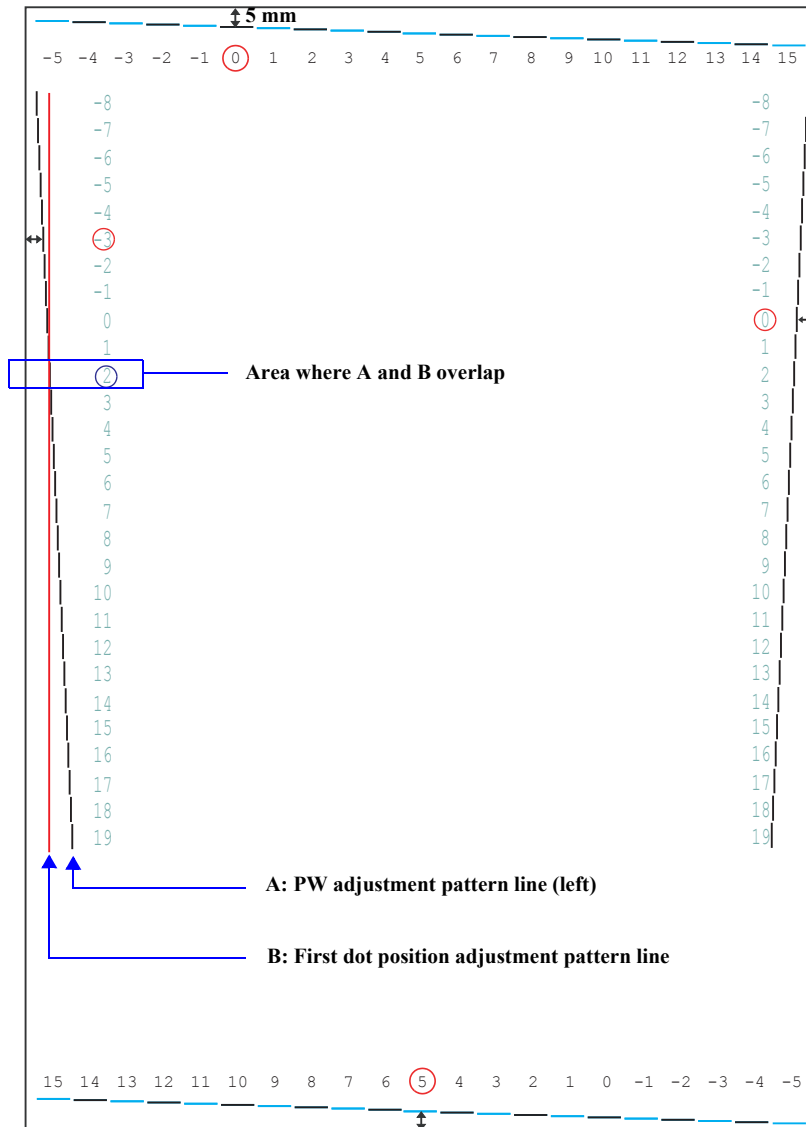

Figure 2-5. PW/First Dot Position Adjustment Pattern

- PW adjustment

How to Judge

Enter the value for the line that is exactly 5mm away from the paper edge for each of the left, right, top and bottom.

Example: In the left figure, enter “0” (top), “0” (right), “5” (bottom) and “-3” (left).

- First dot position adjustment

How to Judge

Enter the value for the point where the PW adjustment pattern line and the First dot position adjustment pattern line overlap on the left of the paper.

Example: In the left figure, enter “2” since the lines overlap at “2” position.

2.2.5 PF Adjustment

- PF- for standard print area

Patterns are printed as shown below.

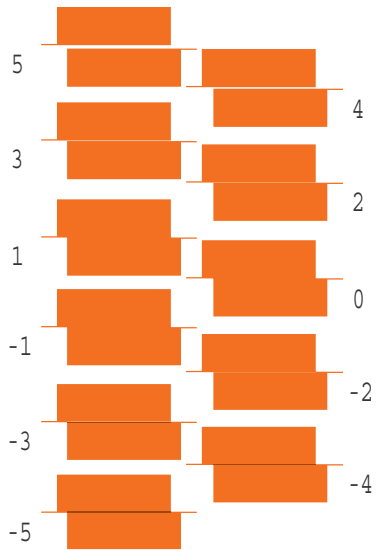

Figure 2-6. PF (standard print area) Adjustment Pattern

How to Judge

Enter the value for the group that has no gap or overlap between the upper and the lower patterns.



Example for judgement

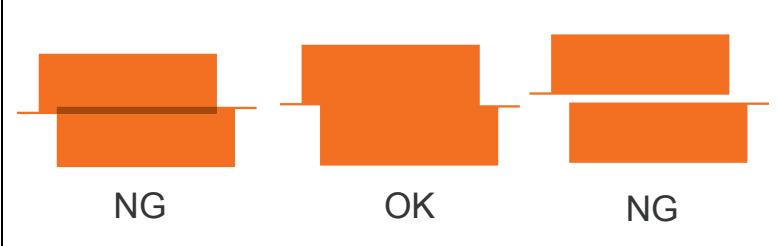

- PF- for bottom margin area

Patterns are printed as shown below.

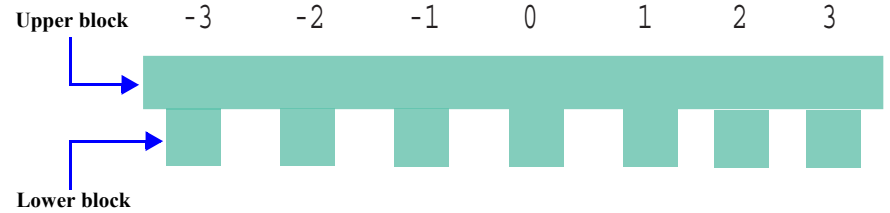

Figure 2-7. PF Adjustment (bottom margin area) Pattern

How to Judge

Enter the value for the one that has no gap or overlap between the upper block and the lower block.

Example: In the above figure, “0” should be selected.

Additional information

In case that all patterns have gap or overlap, select the value for the pattern which has the least gap or overlap, and print the pattern again.



Example for judgement

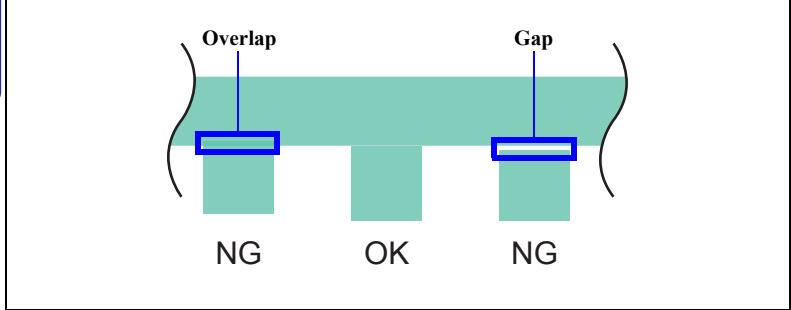

2.2.6 PG Adjustment

Described below is the platen gap (PG) adjustment.

- Purpose:
Adjust the distance between the head surface and the Paper Guide Front Assy (platen) properly and adjust the parallelism on the 0th column side and on the 80th columns side to ensure reliable print quality.
Once the Carriage Assy and/or Adjustment Bushes have been removed or whenever necessary for any other reason, make this adjustment to correct the deviation of the platen gap.

Table 2-5. PG Positions

Position	PG Size (mm)	Application for Printing (selected from PG flag list for normal/head rubbing)	Sequence Application
PG- <APG Home>	1.2	EPSON special thick paper PGPP, Postcards, Matte, etc.	Cleaning CR measurement, VH detection CR home position seek
PG typ. <Mechanical default>	1.7	Plain paper EPSON special thin paper, SF, etc. Rubbing with PG1.2 is avoided	
PG+	2.35	Envelopes Rubbing with PG1.2 and 1.7 is avoided	
PG++	4.2	CD-R printing	At ink replacement

- Things to be used
 - Thickness gauge: 1.15 mm (x2)
1.3 mm (x2)
 - Phillips screwdriver



- The thickness gauge to be used must be free from dust and dirt and from deformation. Be sure to clean it before use.
- Take care that the Print Head is not soiled or scratched.
- To ensure high accuracy of adjustment, install the Adapters in the carriage, and move the carriage right and left by pulling the belt without holding the carriage.



- Make this adjustment after installing the Printer Mechanism and CISS section. (Install the Linear Scale after adjustment.) Refer to “1.2.2 Disassembly Flowchart” (p.18).
- With L800/L801, four stages of PG setting are available by means of the APG Mechanism. However, make this adjustment with the mechanism in the minimum PG position (PG-: 1.2 mm). (Refer to “1.5.4 APG Unit” (p.41) and below.)

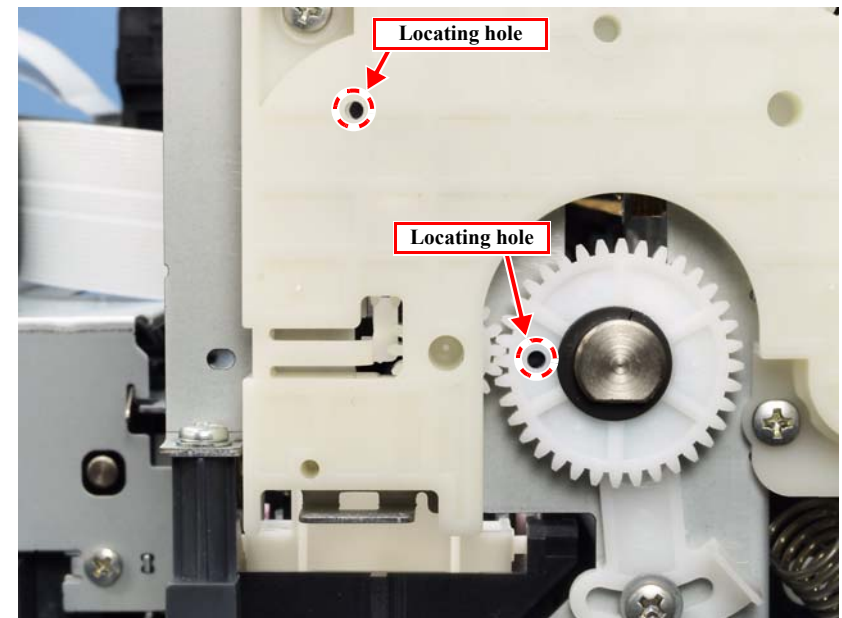

Figure 2-8. PG Position at PG Adjustment

- Adjustment procedure
 - Specified PG value: 1.2 ± 0.1 mm
1. Install new ink cartridges in the carriage.
 2. Remove the Cable Holder Frame. (Fig. 1-75)
 3. Check that the APG Assy and the carriage are in the PG-position. (Fig. 2-8)
 4. Move the carriage to the center of the platen, and place 1.15 mm thickness gauge on the left aligning its left edge with the second rib of the Front Paper Guide. And place another 1.15 mm thickness gauge on the right aligning its right edge with the rightmost rib of the Front Paper Guide. (Fig. 2-9)

NOTE: The thickness gauge must not be set over the leftmost rib on the Front Paper Guide.

5. Pull the Timing Belt to move the carriage to the left end.
6. If the carriage comes in contact with the gauge, adjust the Left Parallelism Bush to raise the carriage to a position where the Printhead does not come in contact with gauge.
7. Pull the Timing Belt to move the carriage to the right end.
8. If the carriage comes in contact with the gauge, adjust the Right Parallelism Bush to raise the carriage to a position where the Printhead does not come in contact with gauge.
9. Move the carriage to the middle area of the platen, and place 1.3 mm thickness gauges at the left and right ends of the platen.
10. Pull the Timing Belt to move the carriage to the left end.
11. If the carriage does not come in contact with the gauge, make the adjustment again.
12. Pull the Timing Belt to move the carriage to the right end.
13. If the carriage does not come in contact with the gauge, make the adjustment again.
14. Mark the indicated graduation position of the right and left Parallelism Bush, and tighten the screws.
(Screw tightening torque: 0.8 ± 0.1 N•m)

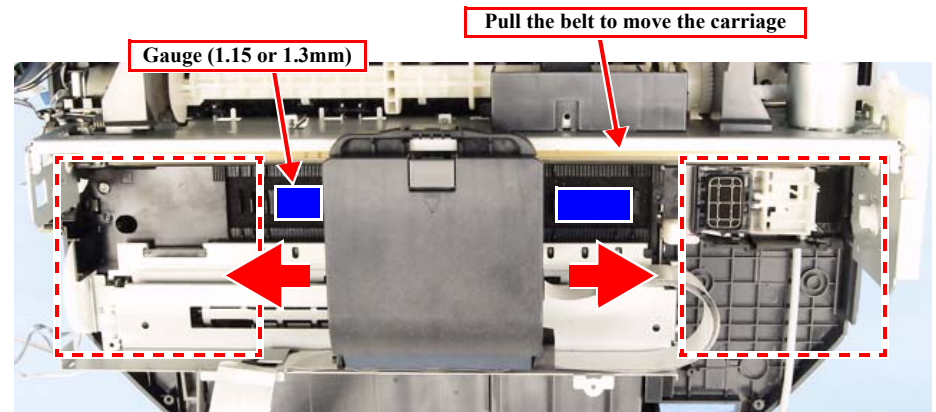
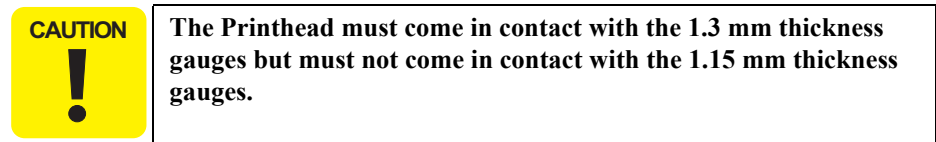

Figure 2-9. PG Adjustment 1

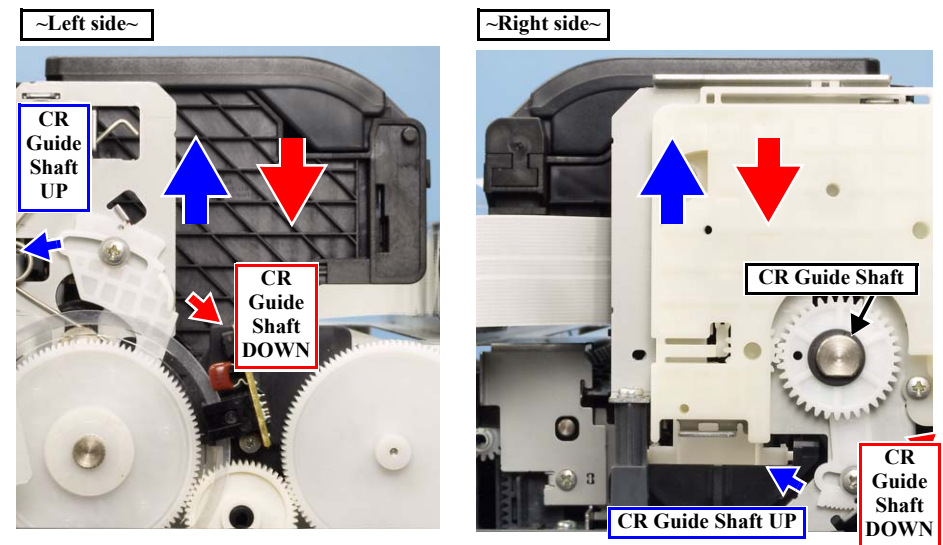

Figure 2-10. PG Adjustment 2

2.3 Banding Reduction System (BRS) Adjustment / Paper Feed Amount Profile (PFP) Correction

2.3.1 Overview

This section explains how to carry out BRS/PFP adjustments.



Be sure to have a specified scanner ready beforehand as it is necessary to carry out the adjustment. Before scanning, confirm that the document table is free from any dirt or stain.

- Tools and paper required to perform the adjustment

Table 2-6. Tools and Paper for BRS/PFP Adjustment

	Tools/Paper	Product Code
Common	PFP Base scale	1453980
BRS	Matte Paper-Heavyweight (A4)	---
PFP	Premium Glossy Photo Paper (4 x 6)	---

Note : When using the following scanners for PFP adjustment, two PFP Base scales are required because they should be set on the origin side and also on right side of the PFP Adjustment Pattern. For the details on their setting positions and such, see “[2.3.2 Adjustment Procedure \(p.85\)](#)”.

- Epson Stylus Photo PX650/TX650/PX660
- Artisan 810/Epson Stylus Photo PX810FW/TX810FW
- Artisan 710/Epson Stylus Photo PX710W/TX710W
- Artisan 835/Epson Stylus Photo PX820FWD/TX820FWD
- Artisan 725/Epson Stylus Photo PX720WD/TX720WD
- Epson WorkForce 630/Epson Stylus Office TX620FWD/ME Office 960FWD
- Epson WorkForce 625/Epson Stylus Office BX525WD/Epson Stylus SX525WD

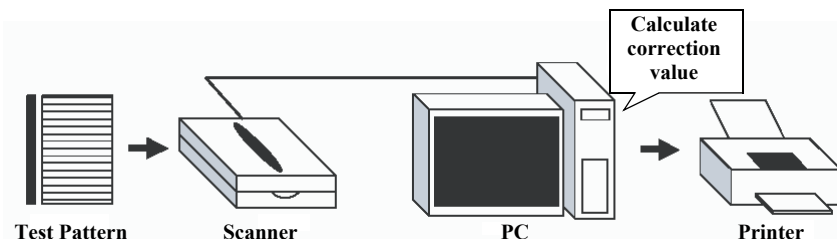

Figure 2-11. System Configuration

- Specified Scanner to perform the adjustment



- Install the driver of the scanner to the PC in advance.
- As the profile required for the adjustment is not prepared for scanners other than the ones specified below, BRS/PFP Adjustment can not be carried out by the other scanners.

The following are the scanners that can be used for scanning the pattern in BRS/PFP adjustment. When starting up the adjustment program, select the scanner to use.

Table 2-7. Specified Scanner for BRS/PFP Adjustment

Model Name	Sensor type	Remarks
Epson Perfection 4990 Photo	CCD	
Epson Perfection V700 Photo	CCD	
Epson Stylus Photo PX650/TX650	CIS	Use the internal scanner.
Artisan 800/Epson Stylus Photo PX800FW/TX800FW	CIS	Use the internal scanner.
Artisan 700/Epson Stylus Photo PX700W/TX700W	CIS	Use the internal scanner.
Artisan 810/Epson Stylus Photo PX810FW/TX810FW	CIS	Use the internal scanner.
Artisan 710/Epson Stylus Photo PX710W/TX710W	CIS	Use the internal scanner.
Epson Stylus Photo RX680/RX685/RX690	CIS	Use the internal scanner.
Epson Stylus Photo RX585/RX595/RX610	CIS	Use the internal scanner.
Epson Stylus Photo RX560/RX580/RX590	CIS	Use the internal scanner.
Epson Stylus Photo PX660	CIS	Use the internal scanner.
Artisan 835/Epson Stylus Photo PX820FWD/TX820FWD	CIS	Use the internal scanner.
Artisan 725/Epson Stylus Photo PX720WD/TX720WD	CIS	Use the internal scanner.
Epson WorkForce 630/Epson Stylus Office TX620FWD/ME Office 960FWD	CIS	Use the internal scanner.
Epson WorkForce 625/Epson Stylus Office BX525WD/Epson Stylus SX525WD	CIS	Use the internal scanner.

CHECK
POINT

Depending on the sensor type of the scanner to use for the adjustment, drying time required after the BRS adjustment pattern has been printed differs. For PFP adjustment pattern/PFP check pattern, drying time is not required.

- For “CCD” sensor:
Printed pattern can be scanned straight away. (Drying time of about 2 minutes is recommended.)
- For “CIS” sensor:
Printed pattern needs to be dried more than 5 minutes.

□ Adjustment Flow

Carry out the adjustment following the adjustment flow below.

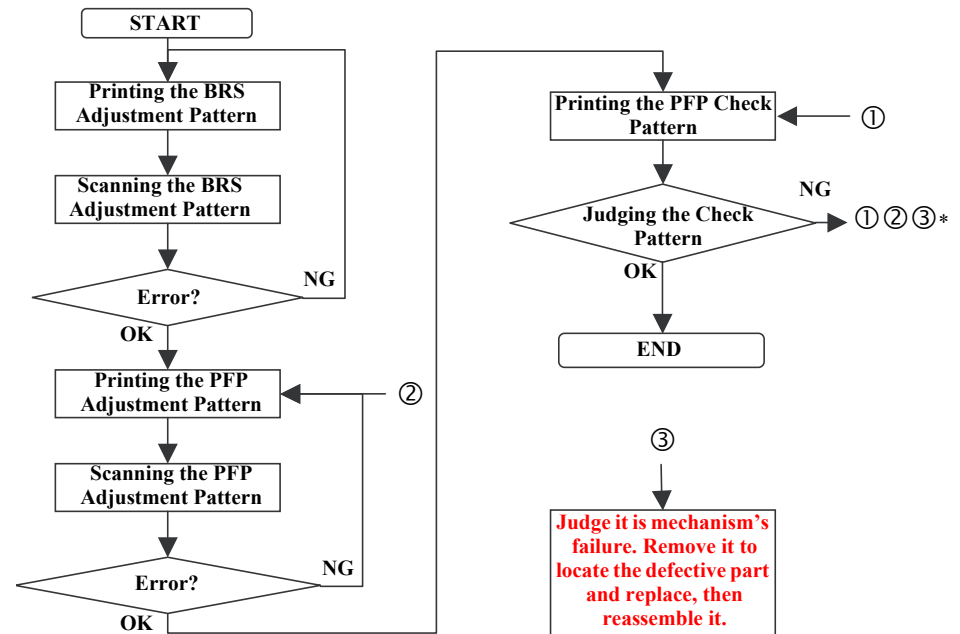

Figure 2-12. BRS/PFP Adjustment Flow

Note*: When a PFP pattern is judged as NG, repeat the steps as described below.

First time NG: retry from ① step

Second time NG: retry from ② step

Third time NG: perform ③ step

CHECK
POINT

When an error is displayed in the Adjustment program, check the points below, then carry out the adjustment again. If an error occurs even after checking the points below, change the scanner with a different one and carry out the adjustment again.

1. Check that the printer that printed the pattern and the printer to register the adjustment value is the same.
2. Check that the printed pattern is placed on the document table of the scanner correctly.
3. Check that there is no gap between the PFP Base Scale and the pattern printed sheet.
4. Check that the scanner glass surface and the PFP Base Scale is free from any dirt or dust.

2.3.2 Adjustment Procedure

2.3.2.1 BRS (Banding Reduction System) Adjustment

□ Printing the BRS Adjustment Pattern

1. Load A4 size Matte Paper-Heavyweight on the paper support.
2. Select [BRS Adjustment] in the adjustment program.
3. Click the [Print] button on the “1. Print Test Pattern” column to print the adjustment pattern.
4. Let the printed pattern dry for more than 5 minutes if using CIS sensor type scanner.

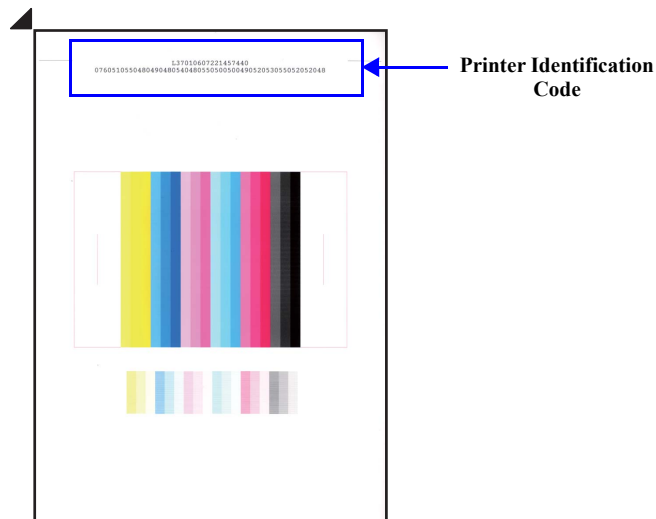

Figure 2-13. BRS Test Pattern

CHECK POINT



- In the Adjustment program, the identification code is used to distinguish whether the printer that printed the pattern and the printer to register the adjustment value is the same.
- Make sure to let the printed pattern dry for more than 5 minutes if using CIS sensor type scanner. When using CCD sensor type scanner, the printed pattern does not need to be dried before scanning. Refer to “Table 2-7. Specified Scanner for BRS/PFP Adjustment” (p. 83)

□ Scanning the BRS Adjustment Pattern

5. Set the printed pattern and the PFP Base Scale on the document table and click the [Scan] button on the “3. Scan Test Pattern” column.
6. According to the scanned result, BRS calibration values are automatically calculated and are written to the serial flash ROM. If an error occurs, check that the document table glass and the scale is clean, and the scale/adjustment pattern is not tilted, then repeat from step 5.

CAUTION



Be careful of the following when setting the PFP Base Scale, and the adjustment pattern on the scanner.

- Place the scale on the document glass aligning the scale corner with the scanner origin position.
- Place the pattern-printed sheet along the scale as shown in the figure below. Make sure to place it parallel to the scale, with no gaps.

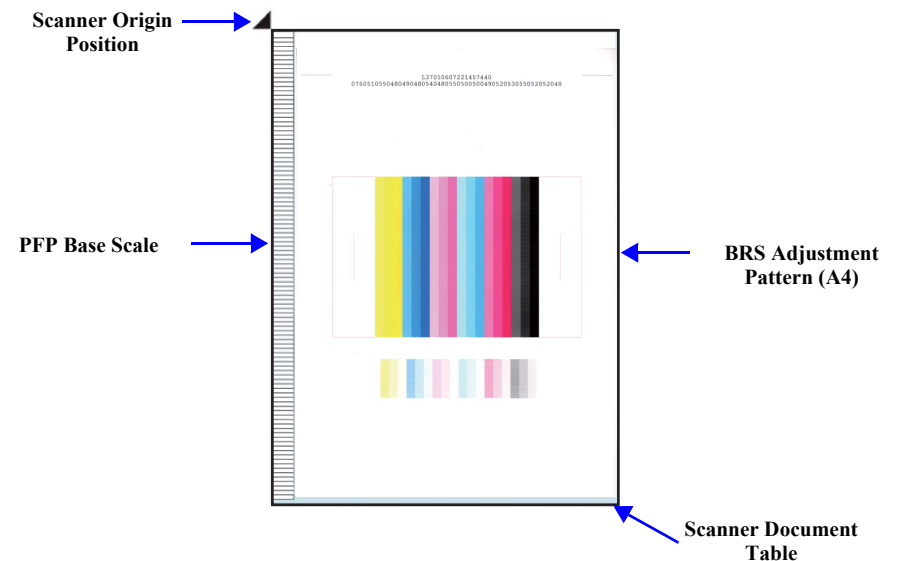

Figure 2-14. PFP Base Scale and BRS Adjustment Pattern Position
(Viewed from the document glass of the scanner)

2.3.2.2 PFP Adjustment

□ Printing the PFP Adjustment Pattern

1. Load 4 x 6 Premium Glossy Photo Paper on the paper support.
2. Select [PFP Adjustment] in the adjustment program.
3. Click the [Print] button on the “1. Print Test Pattern” column to print the adjustment pattern.

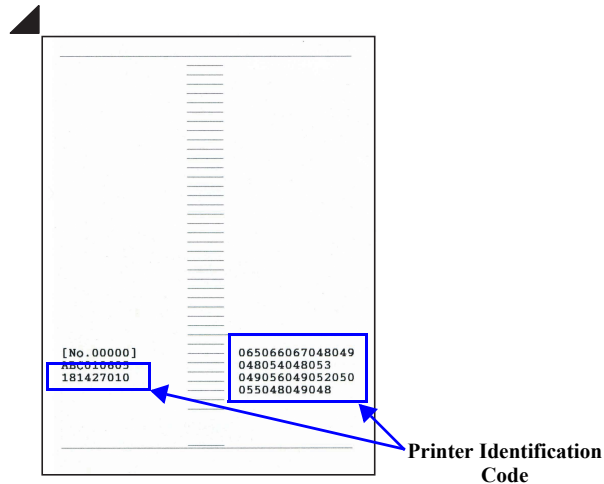

Figure 2-15. PFP Test Pattern

CHECK
POINT

In the Adjustment program, the identification code is used to distinguish whether the printer that printed the pattern and the printer to register the adjustment value is the same.

□ Scanning the PFP Adjustment Pattern

4. Set the PFP Base Scale and the PFP test pattern on the document table and click the [Scan] button on the “3. Scan Test Pattern” column.
5. According to the scanned result, PFP calibration values are automatically calculated and are written to the serial flash ROM. If an error occurs, check that the document table glass and the scale is clean, and the scale/adjustment pattern is not tilted, then repeat from step 4.

CAUTION



Be careful of the following when setting the PFP Base Scale and the adjustment pattern on the scanner.

- Place the scale on the document glass aligning the scale corner with the scanner origin position.
- Place the pattern-printed sheet along the scale as shown in the figure below. Make sure to place it parallel to the scale, with no gaps.

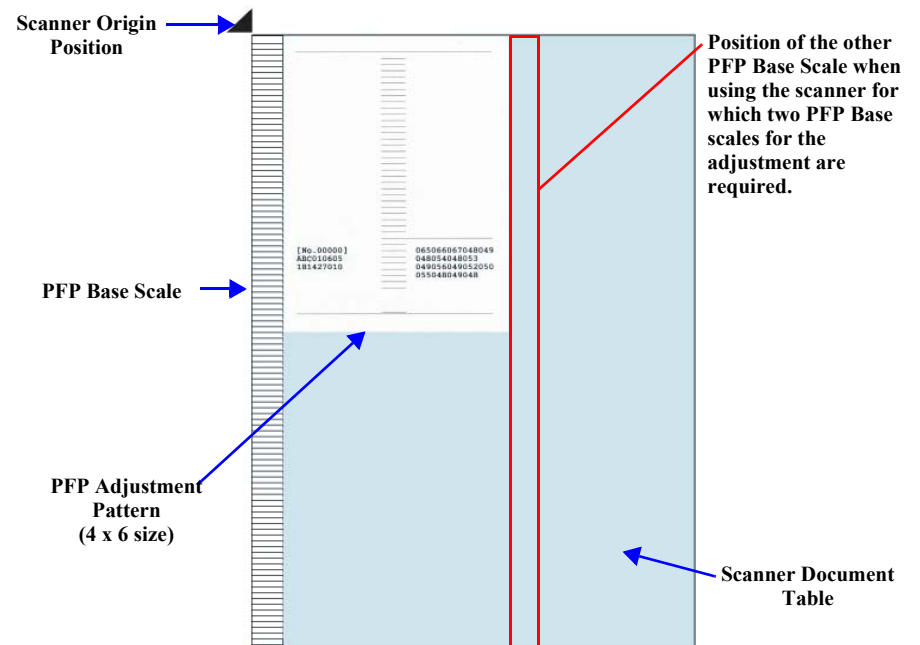

Figure 2-16. PFP Base Scale and PFP Adjustment Pattern Position
(When viewed from the document glass of the scanner)

- Printing the PFP Check Pattern
6. Set 4 x 6 Premium Glossy Photo Paper on the paper support and click the [Print] Button on the “4. Print Check Pattern” column.

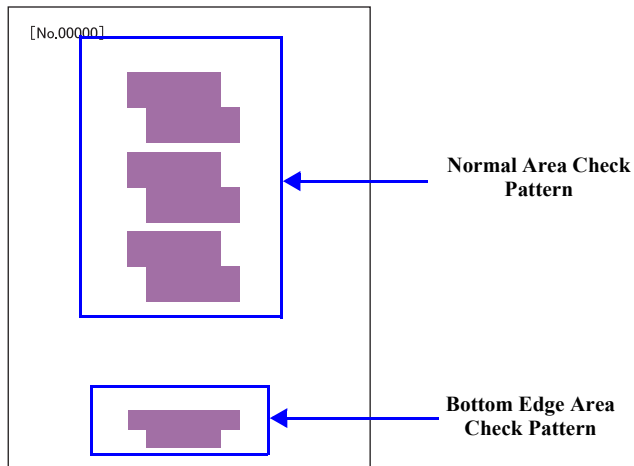

Figure 2-17. PFP Check Pattern

- Judging the Check Pattern
7. Referring to [Fig. 2-18](#) check that there is no white or overlapped bands in all the check patterns. If any bands are found, carry out the steps below.
1. Re-print the check pattern to see if the bands appear again.
 2. When bands appear in Step 1, try the PFP adjustment again from the beginning.
 3. When bands appear even after the re-adjustment in step 2, determine that it is the mechanism failure and carry out check/reassemble of the parts that was removed/replaced.

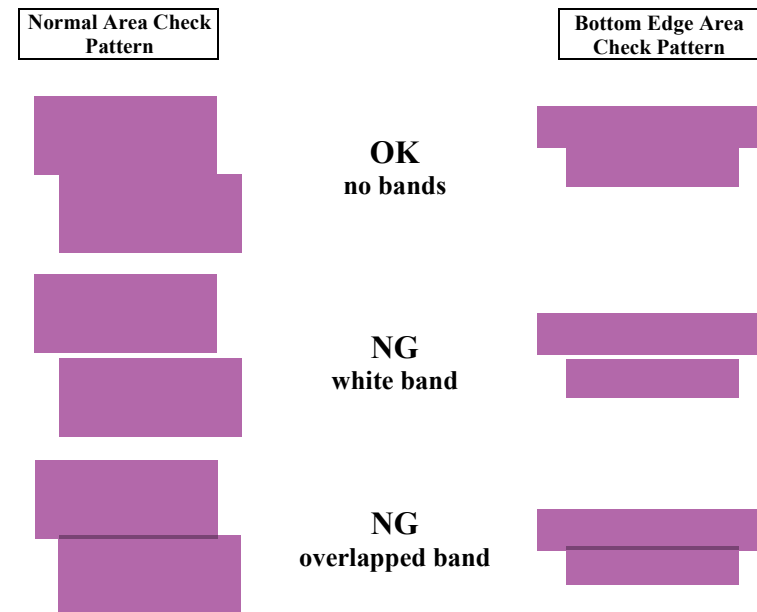

Figure 2-18. PFP Check Pattern Judging Standard

CHAPTER

3

MAINTENANCE

3.1 Overview

This section provides information to maintain the printer in its optimum condition.

3.1.1 Cleaning

Except for the printhead, there are no other mechanical parts or units that require periodic cleaning. However, if need arises, clean the component observing the following instructions.

- Instructions for cleaning
 - Exterior parts such as housing
Wipe dirt off with a soft clean cloth moistened with water.
For glossy or transparent parts, use of unwoven cloth is recommended to avoid scratching those parts.
 - Inside of the printer
Remove paper dust with a vacuum cleaner.
 - Rubber or plastic rollers such as an LD roller used to feed paper
If paper dust adhered to the rollers decreases the frictional force of the rollers and the rollers cannot properly feed paper, wipe off the paper dust with a soft cloth moistened with diluted alcohol.
- Instructions for cleaning ink stains
Wipe the stains off with a cloth wrung out of diluted alcohol.



- **Do not use alcohol for cleaning the transparent parts. Doing so may cause them to get cloudy.**
- **When wiping paper dust off the LD roller, be careful not to rub against the surface asperity.**
- **To minimize the effect on the parts, use diluted alcohol such as 70% diluted ether.**
- **After using alcohol for cleaning, make sure to wipe the part off with a soft dry dust-free cloth to remove alcohol traces fully.**

3.1.2 Service Maintenance

If any abnormal print (dot missing, white line, etc.) has occurred or the printer indicates the “Maintenance request error”, take the following actions to clear the error.

(This error is displayed in EPSON Status Monitor 3 and with LED.)

3.1.2.1 Printhead cleaning

When dot missing or banding appears on images, run the Printhead cleaning cycle.* The cleaning be activated from the control panel, the printer driver utility or the Adjustment program.

Note *: This printer has three manual cleaning modes. The appropriate cleaning mode is automatically selected and performed according to various conditions. The ink consumption amount for manual cleaning varies depending on the mode.

3.1.2.2 Maintenance request error

Ink is consumed also for cleaning and flashing operations. When the ink is used for cleaning and flashing operations, the ink is drained to the Waste Ink Pads via the Pump. The amount of the waste ink is stored as the waste ink counter into the EEPROM. When the waste ink counter has reached the limit of the absorbing capability of the Waste Ink Pads, the maintenance request error is displayed. This printer takes the ink evaporation amount into consideration, therefore the counter limit differs depending on how often printing is made.

When the maintenance request error appears, replace the Waste ink pads with a new one and reset the waste ink counter using the Adjustment program. If the waste ink counter is close to its limit, recommend that the Waste ink pads will be replaced with new one. This is because the “Maintenance request error” will may occur after returning the repaired product to the customer.

3.1.3 Lubrication

The type and amount of the grease used to lubricate the printer parts are determined based on the results of the internal evaluations. Be sure to apply the specified type and amount of the grease to the specified parts during servicing mentioned below.

- When parts that need lubrication is been replaced
- As the need arises during disassembly/reassembly of the printer



■ **Never use oil or grease other than those specified in this manual. Use of different types of oil or grease may damage the component and adversely affect the printer operation.**

■ **Observe the specified amount. Never apply excess.**

Table 3-1. Specified Lubricant

Type	Name	EPSON code	Supplier
Grease	G-71	1304682	EPSON
Grease	G-77	1455324	EPSON

Refer to the following figures for the lubrication points.

LUBRICATION OF DRIVEN PULLEY

	<Lubrication Points> Four points where contact with the Main Frame
	<Type> G-71
	<Application Amount> ø 1 x 4 mm x 4 points
	<Application Timing> Apply before installing the Driven Pulley
	<Remarks> Apply with Injector

Figure 3-1. Lubrication of Driven Pulley (1)

	<Lubrication Points> Two points on bushings for the Pulley Shaft One point at the center of the Pulley Shaft
	<Type> G-71
	<Application Amount> ø 1 x 1 mm x 3 points
	<Application Timing> Apply before installing the Driven Pulley
	<Remarks> Apply with Injector

Figure 3-2. Lubrication of Driven Pulley (2)

	<Lubrication Points> Two points on the side of the Pulley
	<Type> G-71
	<Application Amount> ø 1 x 1 mm x 2 points
	<Application Timing> Apply after installing the Driven Pulley
	<Remarks> Apply with Injector

Figure 3-3. Lubrication of Driven Pulley (3)

LUBRICATION OF FRONT PAPER GUIDE ASSY

<div style="border: 1px solid black; padding: 2px; width: fit-content; margin: 0 auto;">Front Paper Guide Assy (left)</div> 	<p><Lubrication Points> PF Roller Shaft, EJ Roller Shaft and Bushing (3 points)</p> <p><Type> G-71</p> <p><Application Amount> ø 1 x 3 mm x 3 points</p> <p><Application Timing> Apply after installing the Front Paper guide</p> <p><Remarks> Apply with Injector <input type="checkbox"/> Make sure that the coated part of the PF Roller Shaft and rubber rollers on the EJ Roller are free from grease.</p>
--	---

Figure 3-4. Lubrication of Front Paper Guide Assy (1)

<div style="border: 1px solid black; padding: 2px; width: fit-content; margin: 0 auto;">Front Paper Guide Assy (right)</div> 	<p><Lubrication Points> PF Roller Shaft, EJ Roller Shaft and Bushing (2 points)</p> <p><Type> G-71</p> <p><Application Amount> ø 1 x 3 mm x 2 points</p> <p><Application Timing> Apply after installing the Front Paper guide</p> <p><Remarks> Apply with Injector <input type="checkbox"/> Make sure that the coated part of the PF Roller Shaft and rubber rollers on the EJ Roller are free from grease.</p>
--	---

Figure 3-5. Lubrication of Front Paper Guide Assy (2)

LUBRICATION OF EJ FRAME ASSY

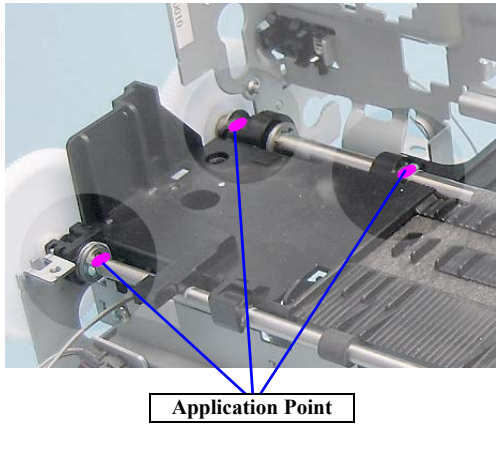
<div style="border: 1px solid black; padding: 2px; width: fit-content; margin: 0 auto;">EJ Frame Assy Bushing</div> <div style="display: flex; justify-content: space-around; margin-top: 10px;"> <div style="border: 1px solid black; padding: 2px; font-size: small;">Left</div> <div style="border: 1px solid black; padding: 2px; font-size: small;">Right</div> </div> 	<p><Lubrication Points> EJ Frame Assy Busing (Left/Right back side)</p> <p><Type> G-71</p> <p><Application Amount> ø 1 x 1mm x 2 points (Right busing, both inner sides) ø 1 x 3mm x 2 points (Left busing, both inner sides)</p> <p><Application Timing> Apply before installing the EJ Frame</p> <p><Remarks> Apply with Injector <input type="checkbox"/> Apply to the both inner sides of the left/right bushings.</p>
--	--

Figure 3-6. Lubrication of EJ Frame Assy

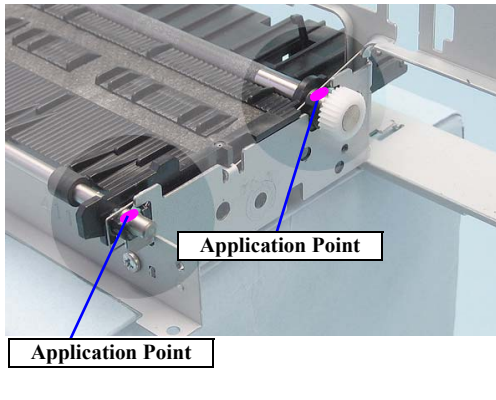
<div style="border: 1px solid black; padding: 2px; width: fit-content; margin: 0 auto;">Front Frame contact point (left)</div> 	<p><Lubrication Points> Contact point between the Front Frame and the PE Frame Assy (2 points)</p> <p><Type> G-71</p> <p><Application Amount> ø 1 x 7mm (Left rib) ø 1 x 3mm (Left notch for spring)</p> <p><Application Timing> Apply before installing the Front Frame</p> <p><Remarks> Apply with Injector <input type="checkbox"/> Apply to the inner edge of the notch for spring.</p>
---	---

Figure 3-7. Lubrication of the Front Frame (1)

<p style="text-align: center;">Front Frame contact point (right)</p> 	<p><Lubrication Points> Contact position of the Front Frame and the PE Frame Assy (2 points)</p> <p><Type> G-71</p> <p><Application Amount> ø1 x 7mm (Right rib) ø1 x 3mm (Right Spring Bushing)</p> <p><Application Timing> Apply before installing the Front Frame</p> <p><Remarks> Apply with Injector <input type="checkbox"/> Apply to the inner edge of the notch for spring.</p>
---	---

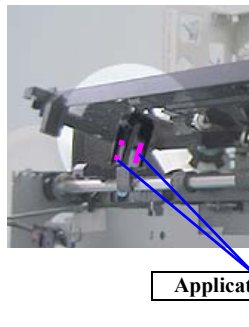
Figure 3-8. Lubrication of the Front Frame (2)

<p style="text-align: center;">PG Cam on both ends of CR Guide Shaft</p> 	<p><Lubrication Points> On the PG Cams attached to the both ends of the CR Guide Shaft</p> <p><Type> G-71</p> <p><Application Amount> ø 1 x 5mm x 3 points</p> <p><Application Timing> Apply after installing the CR Guide Shaft</p> <p><Remarks> Apply with Injector</p>
---	---

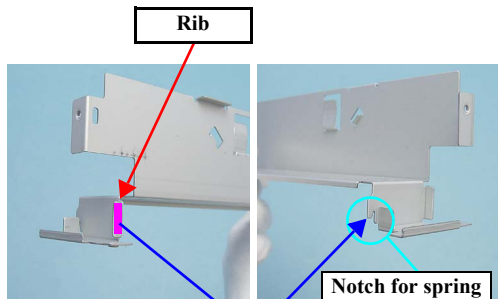
Figure 3-10. Lubrication of the CR Guide Shaft PG Cam

LUBRICATION OF CR UNIT

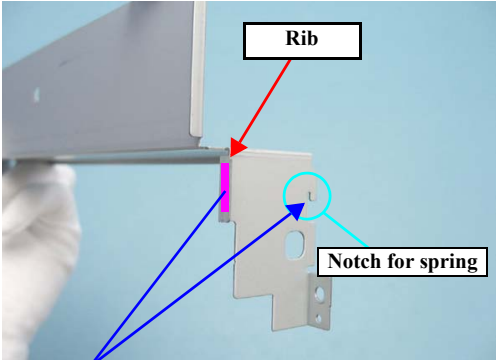
<p style="text-align: center;">Main Frame (upper rear)</p> 	<p><Lubrication Points> On the back of the Main Frame where contact with the CR Unit</p> <p><Type> G-71</p> <p><Application Amount> 160 ± 20mg</p> <p><Application Timing> Apply after installing the CR Unit</p> <p><Remarks> Apply with Injector <input type="checkbox"/> Do not apply to the both ends (40mm from edge) <input type="checkbox"/> Move the CR Unit the left/right to spread the grease evenly.</p>
--	--

Figure 3-9. Lubrication of the Main Frame (1)

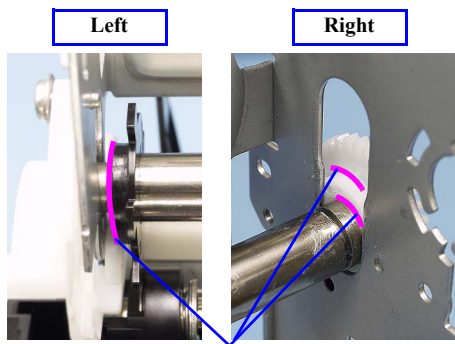
<p style="text-align: center;">CR Guide Shaft Retaining Spring</p> 	<p><Lubrication Points> On the both ends of the CR Guide Shaft to where its retaining springs are attached.</p> <p><Type> G-71</p> <p><Application Amount> ø 1 x 5 mm x 2 points</p> <p><Application Timing> Apply before installing the Spring</p> <p><Remarks> Apply with Injector</p>
--	--

Figure 3-11. Lubrication for the CR Guide Shaft Retaining Spring

<div style="border: 1px solid black; padding: 5px; width: fit-content; margin-bottom: 5px;"> Contact point between CR Unit and CR Guide Shaft (1) </div>  <div style="border: 1px solid black; padding: 2px; width: fit-content; margin-top: 5px;"> Application Point </div>	<p><Lubrication Points> Contact point between CR Unit and the CR Guide Shaft</p> <p><Type> G-71</p> <p><Application Amount> 210 ± 20mg x 2 points</p> <p><Application Timing> Apply before installing the CR Unit</p> <p><Remarks> Apply with Injector <input type="checkbox"/> After lubrication, move the CR Guide Shaft to left and right by 60mm while rotating it, to spread the grease evenly. <input type="checkbox"/> Make sure that the Timing Belt is free from grease.</p>
---	---

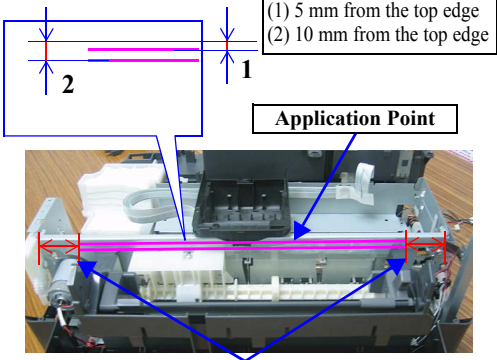
Figure 3-12. Lubrication of the CR Guide Shaft (1)

<div style="border: 1px solid black; padding: 5px; width: fit-content; margin-bottom: 5px;"> Contact point between CR Unit and CR Guide Shaft (2) </div>  <div style="border: 1px solid black; padding: 2px; width: fit-content; margin-top: 5px;"> Application Point: Apply from the holes </div>	<p><Lubrication Points> Lubrication holes of the CR Unit</p> <p><Type> G-71</p> <p><Application Amount> 210 ± 20mg x 2 points</p> <p><Application Timing> Apply before installing the CR Unit</p> <p><Remarks> Apply with Injector <input type="checkbox"/> Apply grease from the two lubrication holes. <input type="checkbox"/> Make sure that the Timing Belt is free from grease.</p>
--	---

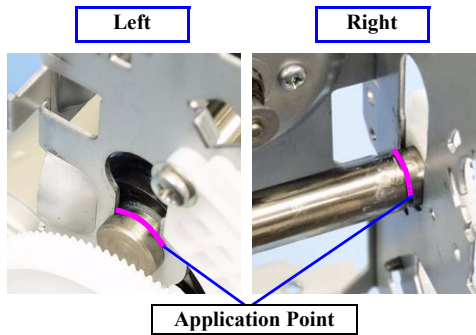
Figure 3-13. Lubrication of the CR Guide Shaft (2)

LUBRICATION OF INK SYSTEM

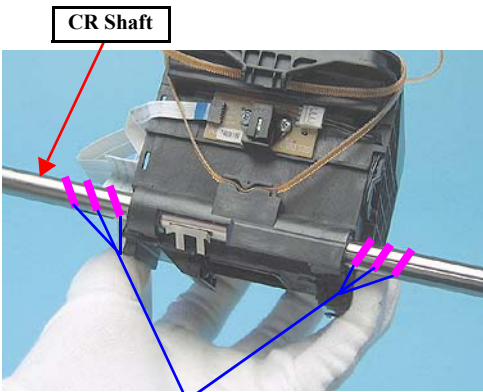
<div style="border: 1px solid black; padding: 5px; width: fit-content; margin-bottom: 5px;"> Contact point between Main Frame and I/S </div>  <div style="border: 1px solid black; padding: 2px; width: fit-content; margin-top: 5px;"> Application Point </div>	<p><Lubrication Points> On the Main Frame where the clutch gear and spring of the Ink System contact</p> <p><Type> G-71</p> <p><Application Amount> ø 1 x 1 circle</p> <p><Application Timing> Apply before installing the Ink System</p> <p><Remarks> Apply with Injector</p>
---	--

Figure 3-14. Lubrication of the I/S

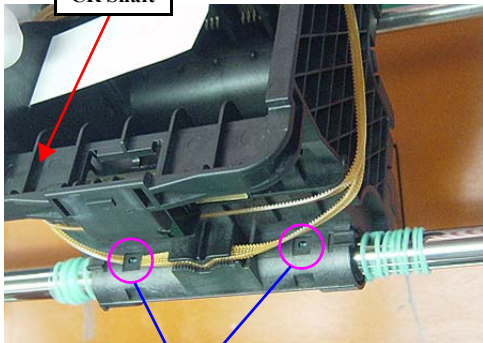
LUBRICATION OF APG UNIT

<div style="border: 1px solid black; padding: 5px; width: fit-content; margin-bottom: 5px;"> Shafts on APG Unit </div>  <div style="border: 1px solid black; padding: 2px; width: fit-content; margin-top: 5px;"> Application Point </div>	<p><Lubrication Points> Around the upper part of the shafts on the APG Unit. (5 points)</p> <p><Type> G-71</p> <p><Application Amount> ø 1 x 1 circle x 5 points</p> <p><Application Timing> Disassemble the APG Unit to apply the grease before installing it.</p> <p><Remarks> Apply with Injector</p>
--	--

Figure 3-15. Lubrication of the APG Unit (1)

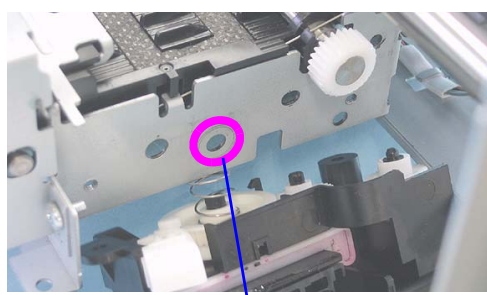
<p>Rim of the APG Unit Spur Gear 28.8</p>	<p><Lubrication Points> Around the rim of the Spur Gear 28.8</p>
	<p><Type> G-71</p>
<p>Application Point</p>	<p><Application Amount> ø 1 x 1 circle</p>
<p><Application Timing> Apply before installing the APG Unit</p>	<p><Remarks> Apply with Injector</p>

Figure 3-16. Lubrication of the APG Unit (2)

<p>LD Roller Shaft (Curved surface)</p>	<p><Lubrication Points> Contact point between the LD Roller Shaft and the Hopper, ASF Gear</p>
<p>USB I/F side</p>	<p>Clutch side</p>
	
<p>Application Point</p>	<p>Application Point</p>
<p><Type> G-71</p>	<p><Application Amount> ø 1 x 10mm x 3 points</p>
<p><Application Timing> Apply before installing the ASF Unit</p>	<p><Remarks> Apply with Injector <input type="checkbox"/> Rotate the LD Roller Shaft so that the Curved/Flat surface face up, then apply grease to the specified parts.</p>

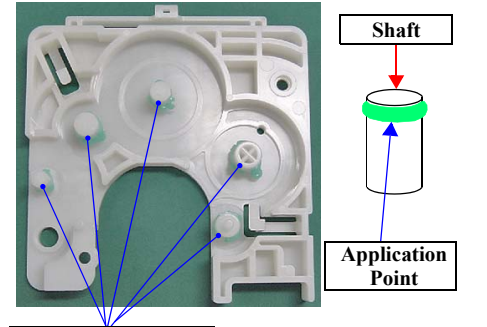
Figure 3-18. Lubrication of the LD Roller Shaft (1)

LUBRICATION OF ASF UNIT

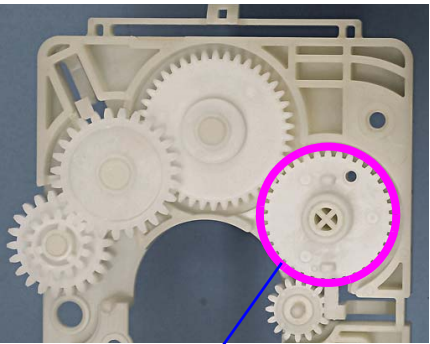
<p>Hole for LD Roller on ASF Unit</p>	<p><Lubrication Points> Inner edge of the hole on the ASF Unit where the LD Roller Shaft is put through</p>
	<p><Type> G-71</p>
<p>Application Point</p>	<p><Application Amount> 1 to 2 circles (inner edge) x 2 points</p>
<p><Application Timing> Apply before installing the LD Roller Assy</p>	<p><Remarks> Apply with Cotton bud</p>

Figure 3-17. Lubrication of the ASF Unit

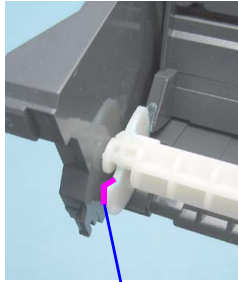
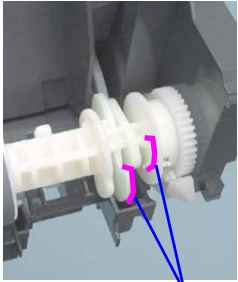
<p>LD Roller Shaft (Flat surface)</p>	<p><Lubrication Points> Contact point between the LD Roller Shaft and the Hopper, ASF Gear</p>
<p>USB I/F side</p>	<p>Clutch side</p>
	
<p>Application point (1)</p>	<p>Application point (2)</p>
<p><Type> G-71</p>	<p><Application Amount> (1) ■ :ø 1 x 20mm x 2 points (2) ■ :ø 1 x 10mm</p>
<p><Application Timing> Apply before installing the ASF Unit</p>	<p><Remarks> Apply with Injector <input type="checkbox"/> Rotate the LD Roller Shaft so that the Curved/Flat surface face up, then apply grease to the specified parts.</p>

Figure 3-19. Lubrication of the LD Roller Shaft (2)

<p>LD Roller Shaft (Curved surface) (Ribs beside the LD Roller)</p>	<p><Lubrication Points> Contact point between the LD Roller and Hopper, ASF Gear</p>
	<p><Type> G-71</p>
	<p><Application Amount> ø 1 x 1/4-circle x 4 points</p>
	<p><Application Timing> Apply before assembling the LD Roller Holder</p>
	<p><Remarks> Apply with Injector <input type="checkbox"/> Rotate the LD Roller Shaft so that the Curved/Flat surface face up, then apply grease to the specified parts.</p>

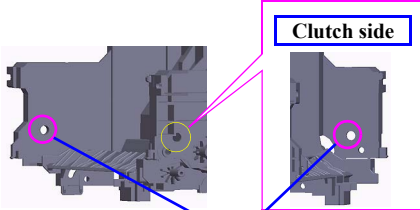
Figure 3-20. Lubrication of the LD Roller Shaft (3)

CHAPTER

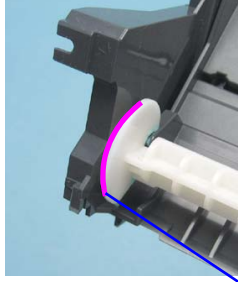
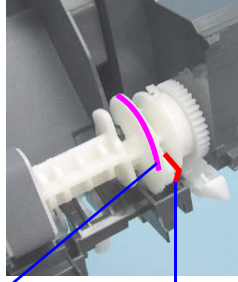
4

APPENDIX

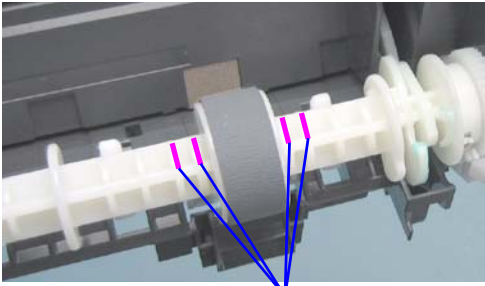
4.1 Power-On Sequence

This section describes the power-on sequences.

- Condition
 - Completing ink charge.
 - No CDR Tray and no paper on the paper path.
 - The stacker is not set on the CDR printing position.
 - The Printhead is capped with the Cap of the Ink System.
 - The Carriage is locked by the CR lock.

Table 4-1. Operation of the power-on sequence









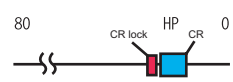

Operation *1	Carriage/PF roller movement and position *2	PG*3
1. Checking waste ink overflow 1-1. Reads out the protection counter value to check waste ink overflow		Any position
2. Avoiding deadlock sequence*4 2-1. The carriage moves to the 0-digit side slowly and confirms it touches the Right Frame.		↓
2-2. The carriage slightly moves to the 80-digit side.		↓
2-3. The PF Motor rotates clockwise and releases the CR lock.		↓
2-4. The carriage moves to the 0-digit side slowly and confirms it touches the Right Frame.		↓
2-5. The carriage returns to its home position.		↓
3. CDR Tray Sensor check 3-1. Checks with the CDR Tray Sensor if the CDR Tray is not set.		↓
3-2. The PF Motor rotates clockwise to eject the CDR Tray.		↓

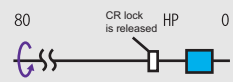
Table 4-1. Operation of the power-on sequence

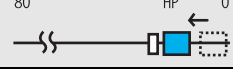
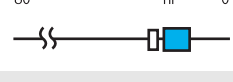
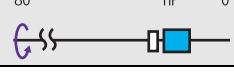
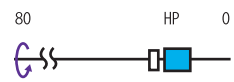
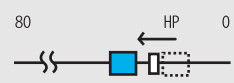
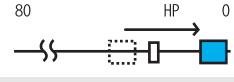
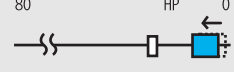
Operation *1	Carriage/PF roller movement and position *2	PG*3
4. Releasing the CR lock 4-1. The PF Motor rotates clockwise and releases the CR lock.		Any position
5. Seeking the home position 5-1. The carriage slowly moves to the 80-digit side.		↓
5-2. The carriage moves to the 0-digit side slowly and confirms it touches the Right Frame.		↓
5-3. The carriage slowly moves to the CR lock set position.		↓
5-4. The PF Motor rotates clockwise and releases the CR lock.		↓
5-5. The PF Motor rotates counterclockwise and sets the CR lock.		↓
5-6. The carriage moves to the 80-digit side slowly and confirms it touches the CR lock.		↓
5-7. The carriage slowly moves to the 0-digit side to the CR lock set position.		↓
5-8. The PF Motor rotates clockwise and releases the CR lock.		↓
5-9. The carriage moves to the 80-digit side slowly and confirms it does not touch the CR lock.		↓
5-10. The carriage slowly moves to its original position, and home position is fixed. Afterward, the carriage position is monitored according to the signals from the CR Encoder.		↓
6. Resetting APG 6-1. The carriage slowly moves to the Right Frame and stops there.		↓

(Continue to the next page)

Table 4-1. Operation of the power-on sequence

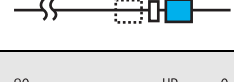
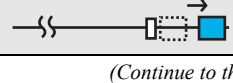
Operation*1	Carriage/PF roller movement and position*2	PG*3
6-2.The PF Motor rotates clockwise while monitoring the PG Sensor.		Any position
6-3.After the PG Sensor switched from Off to On, the PF Motor rotates clockwise by the specified step until it detects the PG-- (APG home position).		↓
6-4. After detecting the APG home position, the carriage slightly moves to the 80-digit side.		↓
6-5. After the PF Motor rotates counterclockwise, it rotates clockwise to confirm the PG Sensor is set to On-state.		PG--
6-6.The carriage slowly returns to its home position.		↓
7. Setting the APG to PG++		
7-1.The carriage slowly moves to the Right Frame and stops there.		↓
7-2.The PF Motor rotates clockwise and sets to PG++.		PG++
7-3.The carriage slowly returns to its home position.		↓
8. PF initialization		
8-1.Checks if paper exists by the PE Sensor*5 and the PF Motor rotates clockwise for one second.		↓
9. PF Motor measurement		
9-1.The PF Motor rotates clockwise for four seconds, and performs a load measurement.*6		↓
10.Low temperature operation sequence*7		
10-1.The PF Motor rotates clockwise, and releases the CR lock.		↓
10-2.The carriage moves back and forth between CR lock and the 80-digit side for two times.		↓

Table 4-1. Operation of the power-on sequence

Operation*1	Carriage/PF roller movement and position*2	PG*3
11.Setting the APG to PG--		
11-1.The carriage slowly moves to the Right Frame and stops there.		PG++
11-2.The PF Motor rotates clockwise and sets to PG--.		PG--
11-3.The carriage slowly returns to its home position.		↓
12.CR measurement and PW Sensor initialization		
12-1.The carriage slowly moves to the 80-digit side.		↓
12-2.The carriage performs a load measurement while moving to the VHCheck position, and records the detected voltage of the PW Sensor at the specified three positions, then stops.		↓
12-3.The carriage detects the voltage of the PW Sensor at the carriage stop position (the black area at the Paper Guide Front).		↓
12-4.The carriage performs a load measurement while moving to the 0-digit side, and stops.		↓
12-5.The carriage performs a load measurement while moving to the VHCheck position, and records the detected voltage of the PW Sensor at the specified three positions, then stops.		↓
12-6.The carriage detects the voltage of the PW Sensor at the carriage stop position (the black area at the Paper Guide Front).		↓
12-7.The carriage performs a load measurement while moving to the 0-digit side, and stops.		↓
13.Detecting ink cartridge and initializing ink system*8		
13-1.The PF Motor rotates clockwise for one second, and resets the PF Roller.*9		↓

(Continue to the next page)

Table 4-1. Operation of the power-on sequence

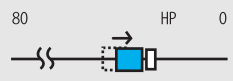
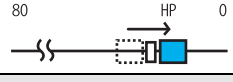
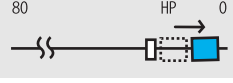
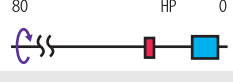
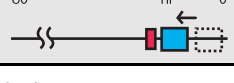
Operation*1	Carriage/PF roller movement and position*2	PG*3
13-2.The carriage slowly moves to the 0-digit side.		PG--
13-3.The carriage slowly returns to its home position.		↓
14.CR lock setting		
14-1.The carriage slowly moves to the CR lock set position.		↓
14-2.The PF Motor rotates counterclockwise, and sets the CR lock.		↓
14-3.The carriage slowly returns to its home position.		↓

Note *1: The rotation direction of the PF Motor is as follows.

Clockwise: Paper is fed normally

Counterclockwise: Paper is fed backward

*2: The condition of the CR lock is as follows.

Red: CR lock is set

White: CR lock is released

*3: Indicates the PG position. "Any position" means that the PG position is not recognized because APG is not reset yet.

*4: Checks if the carriage is not deadlock such as the CR lock is caught in the gap of the carriage.

*5: Eject the paper if any.

*6: When paper exists, the existing measurement value saved in EEPROM is read out; therefore, the PF Motor does not rotate.

*7: Executes when the detected temperature is under 5 °C (41°F) by the thermistor on the Printhead.

*8: The empty sanction operation may occur depending on the situation.

*9: If paper remains in the printer, the PF Roller rotates by steps enough to eject the paper forcibly.

4.2 Standard Operation Time for servicing the product

The following are the standard operation time for servicing the product. Those are based on the MTTR result measured using a prototype.

The underlined parts/units are supplied as After Service Parts.

Table 4-2. Standard Operation Time

Parts/Unit	Time (second)			
	Replacement	Adjustment	Total	
<u>Printer Cover</u>	9	0	9	
<u>Paper Support Assy</u>	13	0	13	
<u>Stacker Cover</u>	10	0	10	
<u>Stacker Assy</u>	7	0	7	
<u>Cover Ink Tube</u>	8	0	8	
<u>Foot</u>	49	0	49	
Housing Upper Assy	132	0	132	
<u>Housing Right</u>	138	0	138	
<u>Decoration Belt Right</u>	146	0	146	
<u>Housing Upper</u>	138	0	138	
Cover open sensor	161	0	161	
<u>Cover FFC</u>	340	0	340	
<u>Cover FFC Inner</u>	327	0	327	
<u>Holder contact</u>	337	0	337	
<u>Printhead</u>	506	3219	3725	
<u>CR Scale</u>	232	0	232	
Main Board Unit	294	0	294	
Upper Shield Plate M/B	483	0	483	
Shield Plate M/B Sub	528	0	528	
<u>Main Board</u>	Read OK	558	105	663
	Read NG	558	2003	2561

Table 4-2. Standard Operation Time

Parts/Unit	Time (second)		
	Replacement	Adjustment	Total
APG Unit	226	0	226
<u>Spur Gear 28.8</u>	242	0	242
<u>Compression Spring 2.25</u>	244	0	244
<u>Spur Gear 12.8</u>	242	0	242
<u>Spur Gear 33.6</u>	242	0	242
<u>Compression Spring 0.97</u>	244	0	244
<u>Combination Gear 12.8,27</u>	258	0	258
<u>Combination Gear 14,22</u>	242	0	242
<u>APG Holder</u>	310	0	310
Panel Assy	224	0	224
Panel Cover Assy	260	0	260
Panel Cover	267	0	267
<u>Decoration Belt Left</u>	267	0	267
Panel Unit	224	0	224
<u>Open Sensor Holder</u>	301	0	301
Panel Shield Plate	316	0	316
Panel Board	362	0	362
<u>Housing Panel Assy</u>	362	0	362
APG Sensor Assy	326	0	326
<u>Photo Interrupter</u>	338	0	338
PF Encoder	323	0	323
PF Scale	304	0	304
Printer Mechanism	1111	3232	4343
Extension Spring	1133	0	1133
Driven pulley Assy	1150	0	1150
<u>Driven Pulley</u>	1176	0	1176
Driven Pulley Shaft	1152	0	1152

Table 4-2. Standard Operation Time

Parts/Unit	Time (second)		
	Replacement	Adjustment	Total
<u>Driven Pulley Holder</u>	1178	0	1178
<u>CR Motor</u>	1193	394	1587
<u>PF Motor</u>	1237	13	1250
<u>Porous Pad Paper Guide Front</u>	1260	0	1260
<u>Ink System Assy</u>	1255	0	1255
<u>Extension Spring 0.8</u>	1315	0	1315
<u>CR Lock</u>	1375	0	1375
<u>Compression Spring 0.98</u>	1259	0	1259
<u>Cable Holder Frame</u>	1223	0	1223
<u>PF Encoder FFC</u>	1223	0	1223
<u>Front Frame</u>	1348	0	1348
<u>EJ Frame Assy</u>	1571	1188	2759
<u>EJ Frame Torsion Spring L</u>	1574	0	1574
<u>EJ Frame Torsion Spring R</u>	1574	0	1574
<u>PF Scale Sheet</u>	1228	0	1228
<u>PF Scale Cover</u>	1250	0	1250
<u>LD Roller Guide Assy</u>	1303	0	1303
<u>Torsion Spring 137.7</u>	1307	0	1307
<u>LD Roller Guide</u>	1307	0	1307
<u>CR Unit</u>	1980	2018	3998
<u>CR Guide Shaft</u>	1990	0	1990
<u>Timing Belt</u>	2055	0	2055
<u>Head FFC</u>	1985	0	1985
<u>Paper Guide Front Assy</u>	2589	1977	4566
<u>PE Lever / PE Lever Torsion Spring</u>	2609	0	2609
<u>Super Gear 26.5</u>	2596	0	2596
<u>Photo Interrupter (PE Sensor)</u>	2596	0	2596

Table 4-2. Standard Operation Time

Parts/Unit	Time (second)		
	Replacement	Adjustment	Total
ASF Unit	1397	559	1956
Holder Roller Retard Assy	1484	0	1484
Combination Gear 16.8.32.8	1403	0	1403
Spur Gear 16	1405	0	1405
Change Lever Assy	1409	0	1409
Compression Spring 2.36	1419	0	1419
Change Lever	1419	0	1419
ASF Assy	1409	0	1409
LD Shaft Roller Assy	1428	0	1428
LD Roller	1501	0	1501
Paper Guide Upper Assy	1437	1224	2661
EJ Ground Spring	2529	0	2529
CDR Tray Sensor	2596	0	2596
Housing Lower Assy	1304	0	1304
Waste Ink Pad Lower	1338	29	1367
Waste Ink Pad Cap Lower	1309	29	1338
Waste Ink Tray	1347	29	1376
P/S Assy	1339	54	1393
Guide Stacker Left	1336	0	1336
Guide Stacker Right Assy	1335	0	1335
CDR Guide Sensor	1341	0	1341
Label CDR	1354	0	1354
Guide Stacker Right	1354	0	1354
Housing Lower	1430	0	1430
Adapter cover	247	0	247
Sheet Guide Tube	483	0	483
Sheet Guide Tube Sub	529	0	529

Table 4-2. Standard Operation Time

Parts/Unit	Time (second)		
	Replacement	Adjustment	Total
Joint	176	1200	1376
Adapter	320	1200	1520
Ink Supply Tube Assy	702	1229	1931
Ink Supply Tank Assy	286	1200	1486
Ink Supply Tank Tube Assy	642	1200	1842
Ink Supply Tank	931	1200	2131
Tube Valve holder rear	61	0	61
Tube Valve holder front	76	0	76
Bottom Cover	142	0	142
Valve Lever	8	0	8
Right Cover	174	0	174
Left Cover	169	0	169
Top Cover	14	0	14
Tube Guide	494	0	494
Cover Joint	36	0	36
Cap	12	0	12
Cover Case	918	0	918
Tube Holder	263	0	263
Valve Position Label	46	0	46
Top Cover Label	46	0	46
Refilling Ink Label	37	0	37

4.3 Troubleshooting

This section describes the troubleshooting workflow and fatal error information.

4.3.1 Troubleshooting Workflow

The following page describes the troubleshooting workflow. Follow the flow when troubleshooting problems.

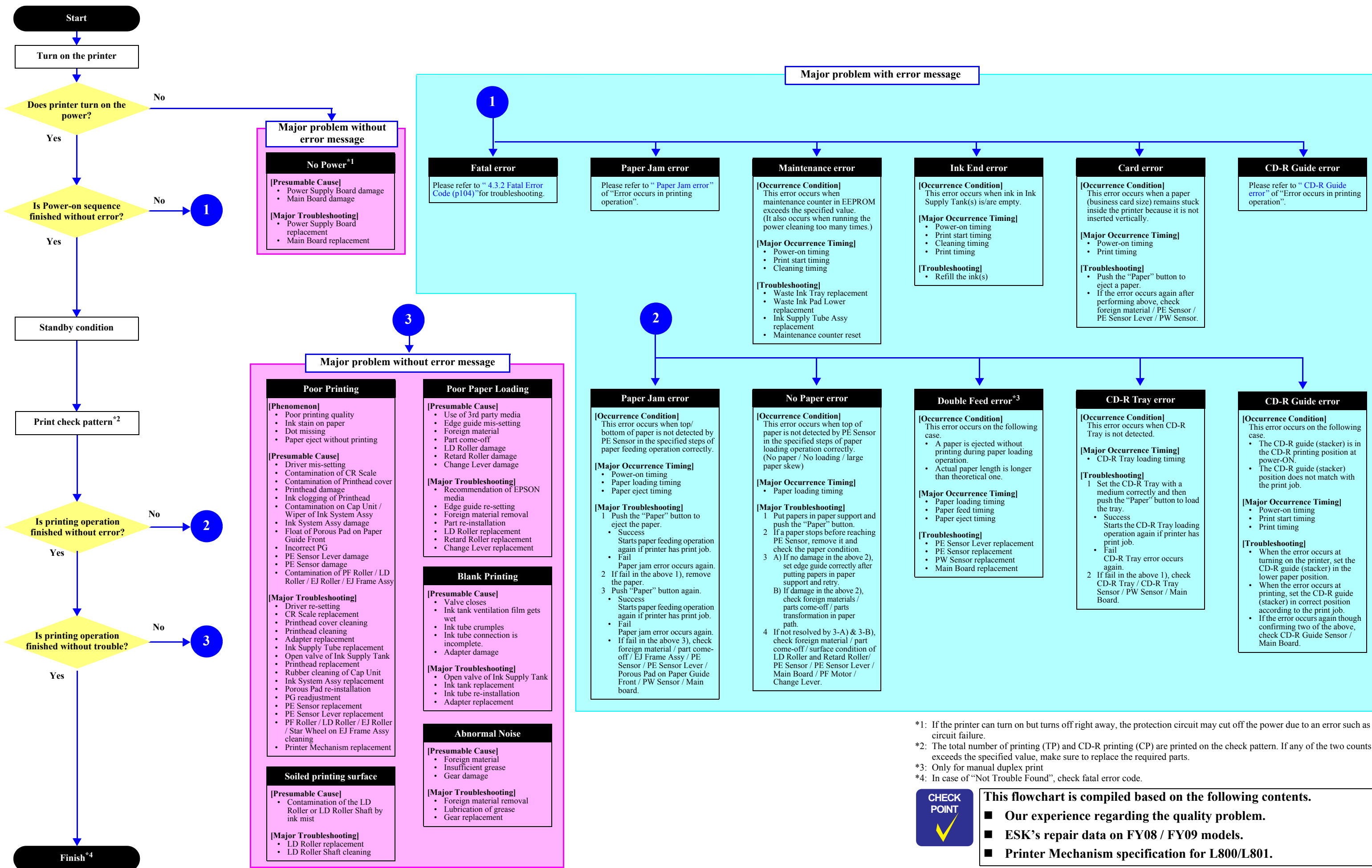

4.3.2 Fatal Error Code

This section describes the fatal error code and the possible cause for this product.

Table 4-3. Fatal Error List

Error type	Error code	Error name	Possible cause
DC motor error	01H	CR PID excess speed error	<ul style="list-style-type: none"> CR Encoder failure (contaminated/detached scale, Encoder Board failure) Motor driver failure (Main Board failure) Carriage overload (paper jam/foreign object) Cable disconnection
	02H	CR load positioning lock error	<ul style="list-style-type: none"> CR Encoder failure (contaminated/detached scale, Encoder Board failure) CR Motor failure Carriage overload (paper jam/foreign object) Cable disconnection
	08H	CR PID reverse error	<ul style="list-style-type: none"> CR Encoder failure (contaminated/detached scale, Encoder Board failure) Tooth skip of the CR Timing Belt Improper tension of the CR Timing Belt Carriage overload (paper jam/foreign object)
	0AH	CR load positioning cumulative movement distance error	<ul style="list-style-type: none"> CR Motor failure Motor driver failure (Main Board failure)
	0BH	CR load positioning excess speed error	<ul style="list-style-type: none"> CR Encoder failure (contaminated/detached scale, Encoder Board failure) Motor driver failure (Main Board failure) Carriage overload (paper jam/foreign object) Cable disconnection
	0CH	CR PID lock error	<ul style="list-style-type: none"> CR Encoder failure (contaminated/detached scale, Encoder Board failure) CR Motor failure Carriage overload (paper jam/foreign object) Cable disconnection
	0DH	CR PID aveTi max error	<ul style="list-style-type: none"> CR Motor failure Motor driver failure (Main Board failure) Improper tension of the CR Timing Belt Carriage overload (paper jam/foreign object)

Table 4-3. Fatal Error List

Error type	Error code	Error name	Possible cause
DC motor error	FBH	PF PID acceleration lock error	<ul style="list-style-type: none"> PF Motor failure PF drive mechanism overload (paper jam/foreign object)
	FEH	PF PID excess speed error	<ul style="list-style-type: none"> PF Encoder failure (contaminated/detached scale, Encoder Board failure) Motor driver failure (Main Board failure) PF drive mechanism overload (paper jam/foreign object) Cable disconnection
	FCH	PF BS excess speed error	
	FAH	PF excess measurement error	<ul style="list-style-type: none"> PF drive mechanism overload (paper jam/foreign object)
	EFH	PF BS control positioning error	<ul style="list-style-type: none"> PF Motor failure Motor driver failure (Main Board failure)
	F0H	PF BS control DTY_max error	<ul style="list-style-type: none"> PF Motor failure PF drive mechanism overload (paper jam/foreign object)
APG motor error	70H	APG error (normal drive error)	<ul style="list-style-type: none"> Foreign object APG Unit failure (incorrect reassembling) APG Sensor failure Cable disconnection
	71H	APG home position seeking error	
	72H	APG drive error (by command)	---
Motor drive time error	D1H	CR (PID) driving time error	<ul style="list-style-type: none"> Main Board failure
	D2H	CR (load positioning) driving time error	
	D3H	PF (PID) driving time error	
	D4H	PF (BS) driving time error	
Command error	30H	EEPROM verify error (by command)	---

Table 4-3. Fatal Error List

Error type	Error code	Error name	Possible cause
Printhead system error	40H	Transistor temperature error	• Main Board failure
	41H	X-Hot detection error (before printing)	• Printhead failure • Main Board failure
	42H	X-Hot detection error (before flushing)	
	43H	Head temperature error	
Sequence error	50H	Home position seeking error	• Paper jam • Foreign object • Deformation of the frame
	51H	CR lock release error	
	52H	CR lock error	
	53H	Card error (before initial ink charge)	• Foreign object
	56H	Impossible contact error (at powering off)	---*
Sensor error	60H	PW sensor error (Hi check error)	• PW Sensor failure • Main Board failure
	61H	PW sensor error (Low check error)	
	62H	Tray sensor error	• CDR Tray Sensor failure • Main Board failure
	63H	PE sensor error	• PE Sensor failure • PE Sensor Lever failure • Main Board failure

Table 4-3. Fatal Error List

Error type	Error code	Error name	Possible cause
Maintenance error	A0H	Waste ink overflow	• The maintenance counter has reached a limit. (Waste Ink Tray or Waste Ink Pad Lower)
Abnormal operation	88H	Tray insertion error (during cleaning)	• Foreign object • CDR Tray Sensor failure • Main Board failure
	89H	Impossible contact error (during cleaning)	• Paper jam • Foreign object • Deformation of the frame • PF Motor failure • PF drive mechanism overload (paper jam/foreign object)

Note " "*": Not occurs except in manufacturing process.